

MULTNOMAH COUNTY LIBRARY, PORTLAND OR



3 1168 03090 3957

# ELLENKANT - JAGDTIGER STURMTIGER

Rarities  
of the Tiger Family

SCHIFFER  
MILITARY  
HISTORY  
VOL. 18

Wolfgang Schneider



Drawing of the Jagdtiger with Porsche chassis.

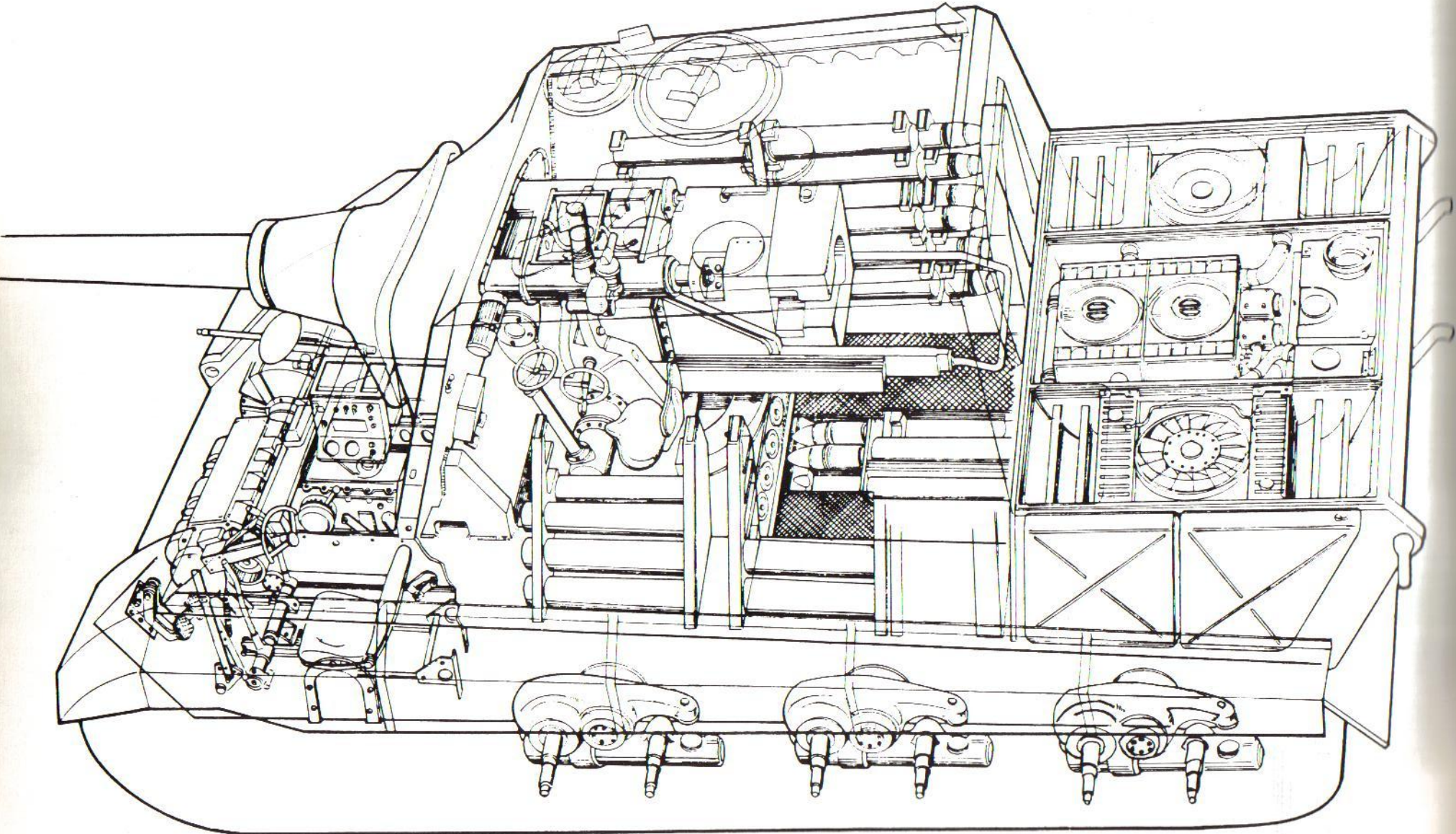

Rarities  
of the  
Tiger Family

695  
**ELEFANT  
JAGDTIGER  
STURMTIGER**

Wolfgang Schneider



1469 Morstein Road, West Chester, Pennsylvania 19380

## NOTES AND ACKNOWLEDGEMENTS

In the difficult research on the origin and action of the comparatively rare armored vehicles of the Tiger family, I am indebted to numerous former members of the appropriate troop units. Particularly valuable assistance was rendered by Otto Carius, Albert Ernst, Rolf Fromme, Walter Scherf, Gerhard Tebbe, Erich Zippel, as well as Willi Mues ("The Great Pocket"). The drawings used were taken, slightly modified by the author, from the following sources: D 656/1 (Elefant), D 1884 (Jagdtiger) and WK B 21 (Sturmtiger).

Many thanks for making photographic material available to: British Tank Museum in Bovington, Uwe Grein, Hauptmann Kosinski (BWB), Walter Spielberger, Wehrtechnische Studiensammlung in Koblenz. The other pictures came from the author's archives.

Translated from the German by Dr. Edward Force,  
Central Connecticut State University.

Copyright © 1990 by Schiffer Publishing.  
Library of Congress Catalog Number: 90-60478.

All rights reserved. No part of this work may be reproduced or used in any forms or by any means—graphic, electronic or mechanical, including photocopying or information storage and retrieval systems—without written permission from the copyright holder.

Printed in the United States of America.  
ISBN: 0-88740-239-9

This book originally published under the title,  
*Elefant, Jagdtiger, Sturmtiger*,  
by Podzun-Pallas Verlag, 6360 Friedberg 3 (Dorheim),  
© 1986. ISBN: 3-7909-0271-3.

We are interested in hearing from authors with  
book ideas on related topics.

## EDITOR'S FOREWORD

This volume follows *The Tiger Family* and stands out particularly for its many hitherto unpublished photographs.



This photo shows the spiritual father of mechanized warfare with large tank units and the creator of the German Panzer weapon, Generaloberst Heinz Guderian. In his capacity as Inspector General of the Panzer Troops he is inspecting the two newly formed Panzerjäger units, equipped with Elefant tanks, at their initial gunnery and combat training.

He had taken up his new position a few weeks before (March 1943), after having been relieved, after considerable controversy with the OKW, of his position as Commander of the 2nd Panzer Army in Russia. After the heavy losses of the tank units in the winter of 1941-42 and the Stalingrad debacle early in 1943, he could not be dispensed with for the rebuilding of the tank units for the decisive battle of the summer of 1943. But once again, many of his warnings were not taken into consideration. Guderian was skeptical about ponderous weapon systems such as the Elefant, and their experiences in battle tend to justify his standpoint.

## Panzerjäger Tiger (P), "Elefant" DEVELOPMENT

During the course of development of the Tiger I tank, two different chassis prototypes (VK 4501) were competing with each other, one made by Porsche and the other by the Henschel firm.

All Porsche's efforts to make his version ready for series production could not be concluded successfully. Technical problems with the running gear, motor and transmission that could not be solved in time, plus the results of technical testing, led to the decision made on October 31, 1942 in favor of the Henschel version. Meanwhile production had commenced at the Henschel works in Kassel, but Porsche too had begun production at the Nibelungen works. When production was ordered stopped, 91 hulls had been finished. These were "replanned" for the production of a heavy assault gun.

The Altmärkischen Kettenwerke GmbH (ALKETT) presented appropriate design drawings in December of 1942. Of greatest urgency were the production of the long-barreled 88mm L/71 antitank gun and frontal armor 200mm thick.

Even before the already existing technical problems could be solved, Hitler ordered on February 7, 1943 that the preparation of the vehicle, at first named "Ferdinand" (after Porsche) and now intended to be a Panzerjäger (tank destroyer), be hurried.

Thus the development and introduction of this Panzerjäger was under an unlucky star from the beginning; weaknesses in the durability of important components and a chassis that was fully overburdened by the installation of a heavy weapon system and increased armor thickness resulted in serious limitations of its usefulness to the troops.

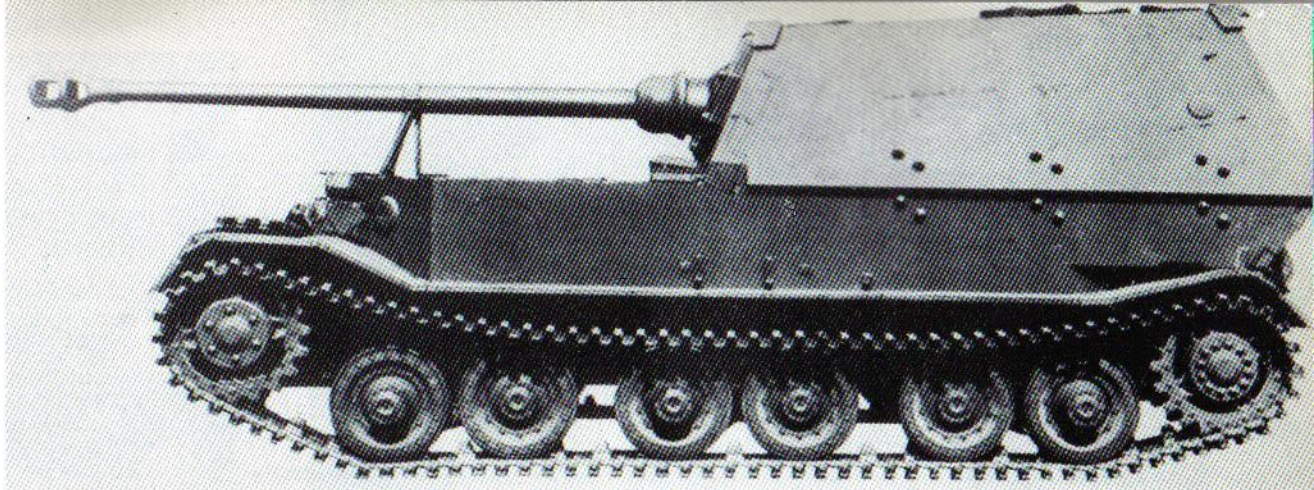

Side view of the Elefant; the running gear with the three sets of road wheels and the cogged road and drive wheels can be seen clearly. The circular cover on the front of the hull is the welded opening of the original escape hatch for the driver and radioman.

This diagonal view shows the two 100mm armor plates that were bolted onto the front of the hull and the gun turret. The six pairs of bolt heads on the turret and the hull just below serve to attach the steel steps used as a connection inside.

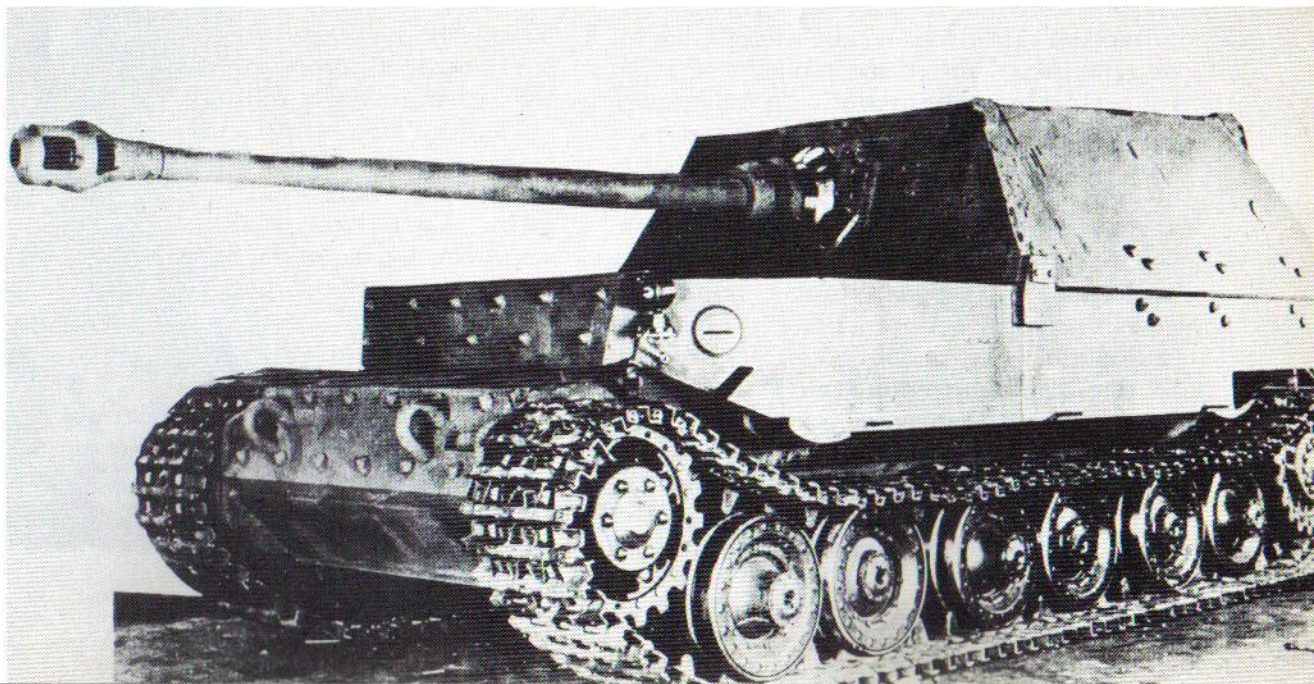

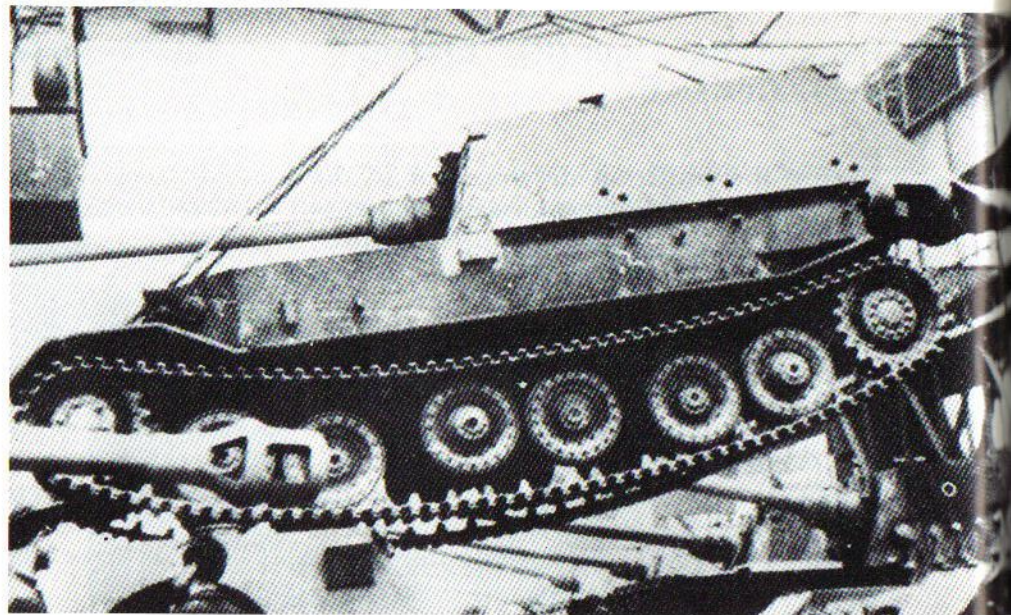
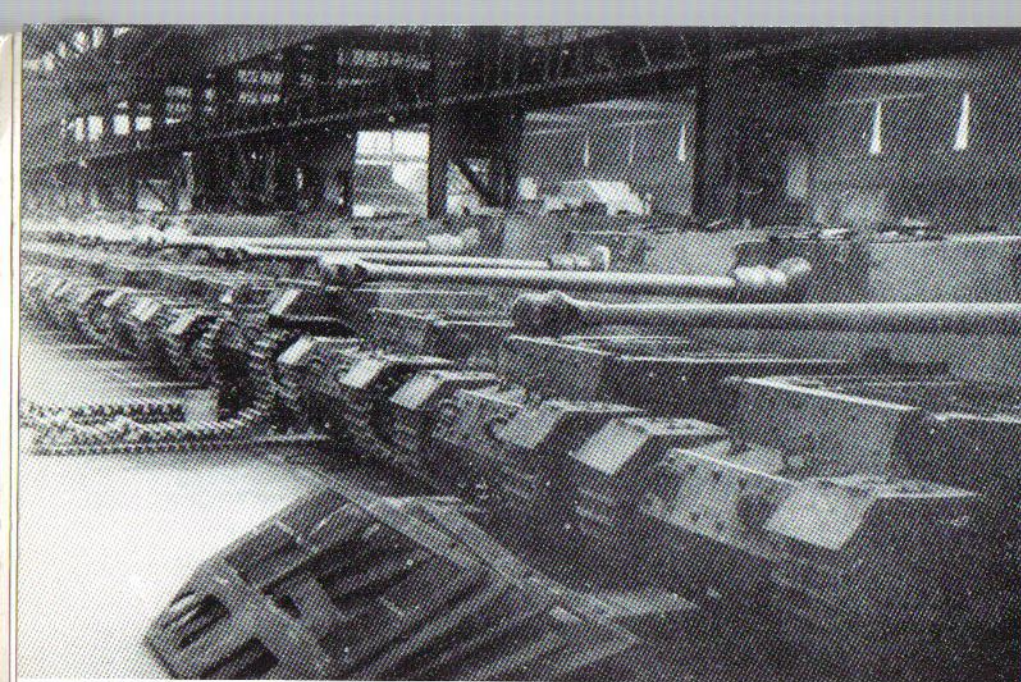

Pictures from the Nibelungen Works early in 1943, a few weeks before the rebuilding work was finished. The picture above shows vehicles 50, 51 and 53 in the foreground. At upper right, an almost finished Elefant (at that time still called Ferdinand) is being moved by a 100-ton factory crane. As the running gear is hanging loose, the paired axle units can be seen clearly.

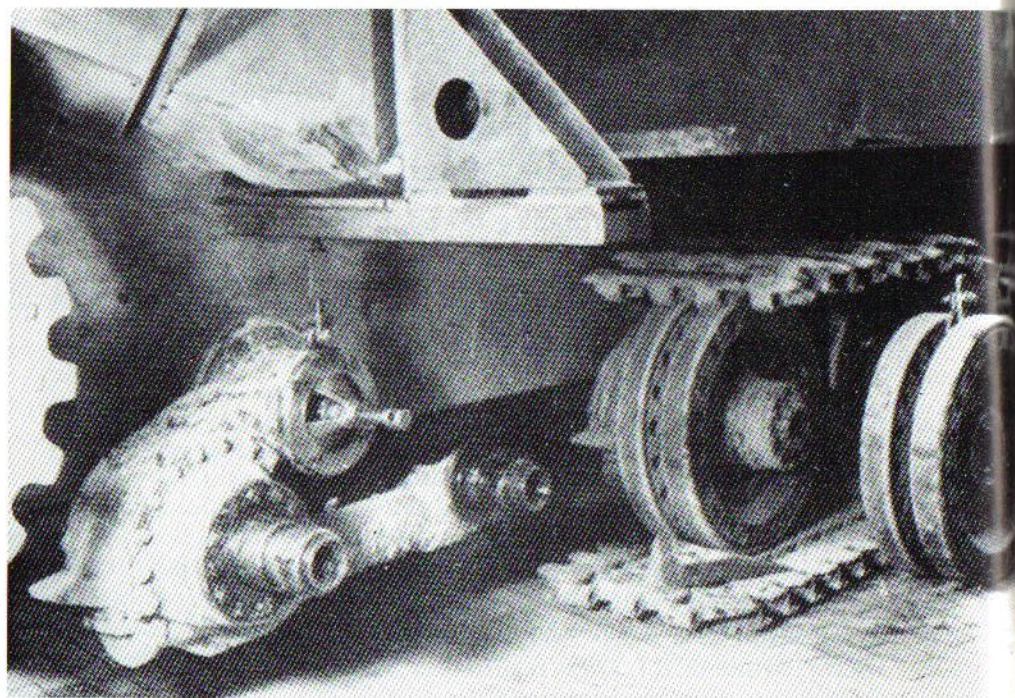

The picture at right was taken shortly before the road wheels were mounted. The upper attachment is clearly seen, as are the two road wheel mounts (left) and the secondary arm (right), which simultaneously covered the torsion bar.

## REBUILDING MEASURES

At the Nibelungen Works, 90 of the 100 usable Porsche chassis (numbers 150001 to 150100) were gradually rebuilt into tank destroyers. Extensive changes to the inside of the hull were necessary for this purpose, since the weapon system had to be moved to the rear of the vehicle; otherwise the Panzerjäger would have been top-heavy.

The driver's compartment at the front was now completely cut off from the rear fighting compartment by the engine room located between them.

The drive wheels were left at the rear.

Between the driver, sitting to the left at the front, and the radioman located beside him, were the compression cylinders for the hydro-pneumatic steering, while the radio equipment (one Fu 5 and one Fu 2) was installed next to the radioman's seat.

The drive, cooling system and fuel tanks were installed in the fighting compartment.

The front plates of the hull and superstructure were each reinforced with a 100mm steel plate to provide the required thickness of 200mm. The rear of the Panzerjäger was made of a box-like armored superstructure, tapering in toward the top, to contain the weapon system; the armor plate was 200mm thick at the front, 80mm on the sides. The antitank gun was installed, partly able to turn, in a circular hatch. On the roof of the fighting compartment were two cupolas and the opening for the gunner's aiming periscope, which swung with the lateral movement of the gun. On each side in the rear part of the superstructure was a close-combat port opening from inside. The rear part of the fighting compartment consisted of a large round screwed-down cover plate, through the opening of which the gun and

mount could be removed to the rear if necessary.

A movable round port for shell ejection was set in this plate. There were two more close-combat ports, one set to either side of the servicing panel.

The relatively unprotected conical shutter tube was given makeshift protection in the form of a two-section armor shield before the tanks were sent to the eastern front.

The rebuilding of the Panzerjäger was completed by May 8, 1943. Their official designation was "Panzerjäger Tiger (P) — Elefant — for 88mm Pak 43/2 L/71 (Sd.Kfz.184)."

## DRIVE

The electric drive system, very modern in terms of its technical design, that had been planned for the VK 4501 (P) was also used for the "Elefant." Two Siemens-Schuckert electric motors installed side by side in the rear of the vehicle directly drove the drive wheels, with a lateral ratio of 1:16.75.

The power for the electric motors was provided by one generator apiece, each driven by an Otto carbureted motor. Instead of the air-cooled motors originally designed for the Porsche Tiger tank, which were technically not yet ready for series production, air-cooled Maybach motors, Type HL 120 TRM, were used. These V-12 motors (bore 105mm, stroke 115mm) displaced 11,867cc and developed a maximum of 300 HP at 3000 rpm with a compression ratio of 6.5:1. The carburetor was a Solex 40JFF II downdraft type. Two HL 120 TRM were mounted side by side in the engine room. The generator mounted on the motor was driven by a V belt. A 540-liter fuel tank was installed beside each motor.

The Porsche-Siemens gearbox had three forward and three reverse gears and was

shifted electrically. The vehicle was steered hydropneumatically. The electrically activated compressed-air brake system (Porsche-Siemens) worked directly on the drive wheels by means of inner brake shoes.

The installation of two motors instead of just one was decided on primarily because of the too-low hull height and the size of the two generators.

## RUNNING GEAR

Similarly innovative to the drive system was the chassis suspension. To save space in comparison with the transverse torsion bar system that had been used in tanks and achieve greater suspension distances by means of smaller road wheels, Porsche had developed the so-called "Federstab-Rollenwagen-Prinzip" with longitudinal torsion bars.

This principle had been tested in 1941-42 in the VK 3001 (P).

Here two road wheels were attached to a central point. To this point was attached a free-swinging carrying arm with a spindle for the one (primary) road wheel. The interior of this spindle was simultaneously an attachment for the second carrying arm for the other road wheel. This carrying arm was hollow and served as the housing for the torsion bar. This was attached to the free end of the hollow arm. With the other end — guided by a cam — it affected the underside of the primary arm. When pressure was put on the primary wheel, the carrying arm swung upward, but was opposed by the torsion-bar suspension. This counter-pressure produced an equal upward movement of the second carrying arm.

Each side of the running gear had three of these pairs of wheels, with six pairs of double steel rollers. The drive wheels at the rear had

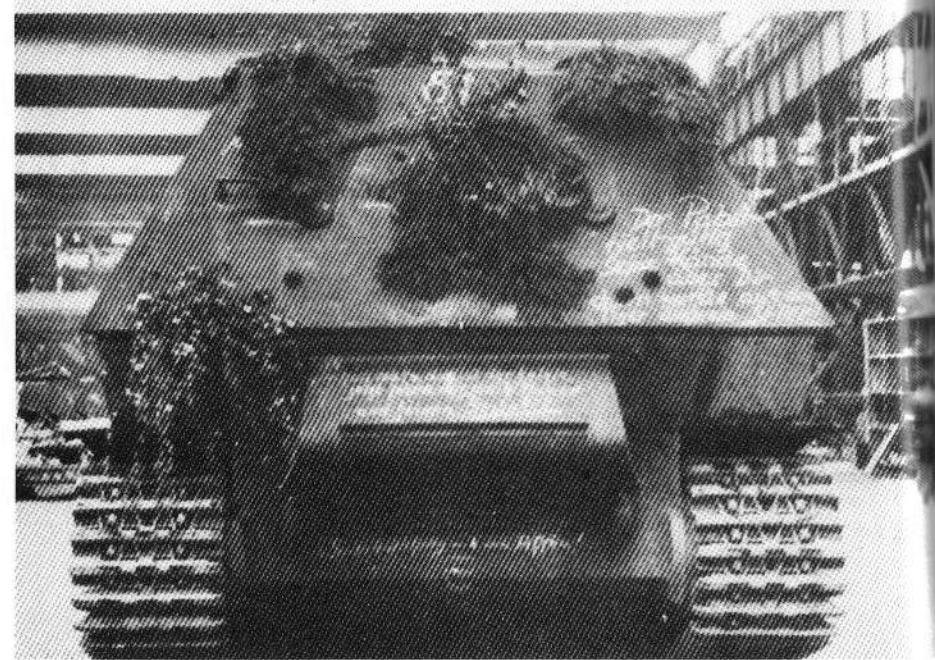
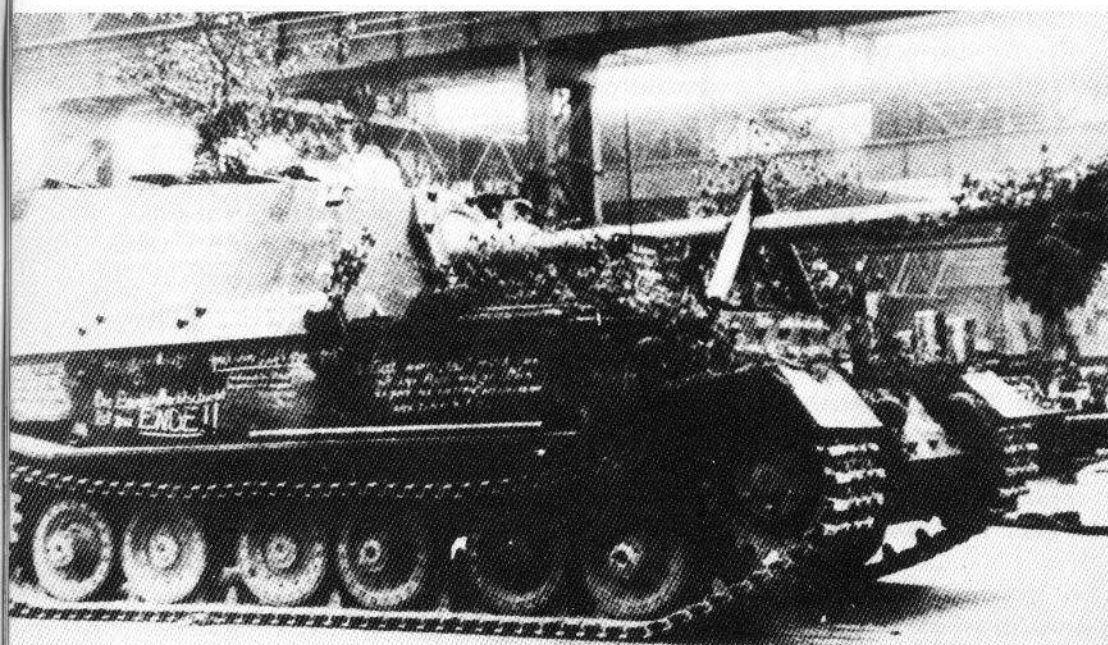

Photo sequence showing the last rebuilt Elefant shortly before it left the factory on May 8, 1943. The usual practice was to say farewell to the last vehicle, decorated with humorous or even political drawings in chalk, in a short ceremony.



a diameter of 794mm; the leading wheels at the front also had cogs for the purpose of better track guiding. The track tension was regulated by a turning spindle that worked against the leading wheel.

The unlubricated steel link tracks, Kgs 62/640/130, had a link length of 4.175mm. The ground pressure of 1.23 kp/cc was more than 20% less favorable than that of the Tiger I tank.

The Panzerjäger had a track width of 2680mm and a ground clearance of 480mm.

### MOBILITY:

The high ground pressure of the overloaded chassis and the inevitably unfavorable performance range of the too-weak drive resulted in a very unsatisfactory degree of mobility. Thus the speed on the road was at best 30 kph, with a maximum range of 150 km. The Elephant could often travel cross-country only at a walking pace. Water up to only one meter deep could be forded.

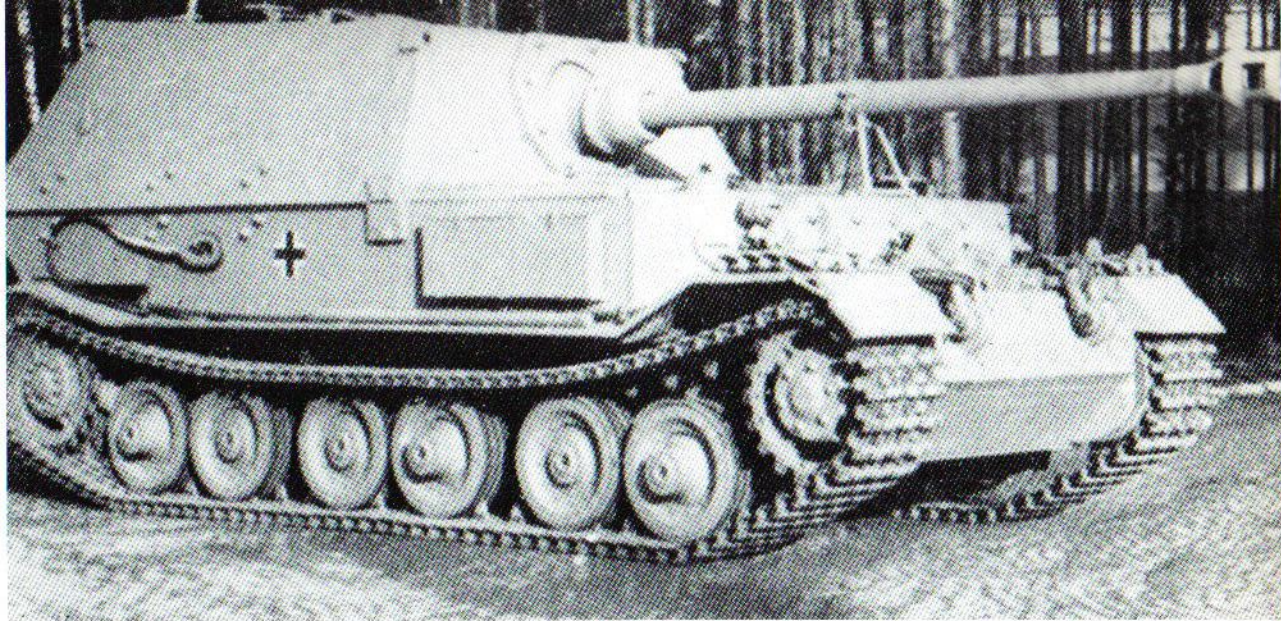

A finished Elephant just after leaving the factory. The gun is held in place by the externally attached barrel brace.

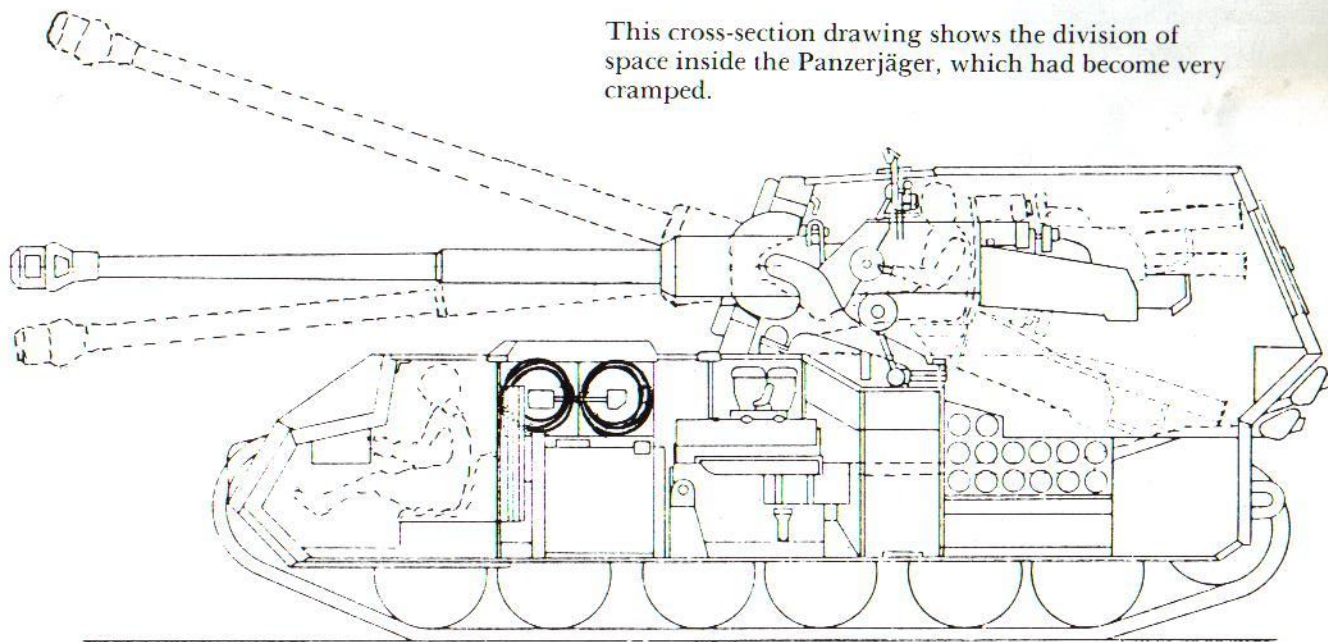

This cross-section drawing shows the division of space inside the Panzerjäger, which had become very cramped.



Above: A camouflaged Elefant secures a makeshift company battle station; the entrance to the lower station can be seen at right.

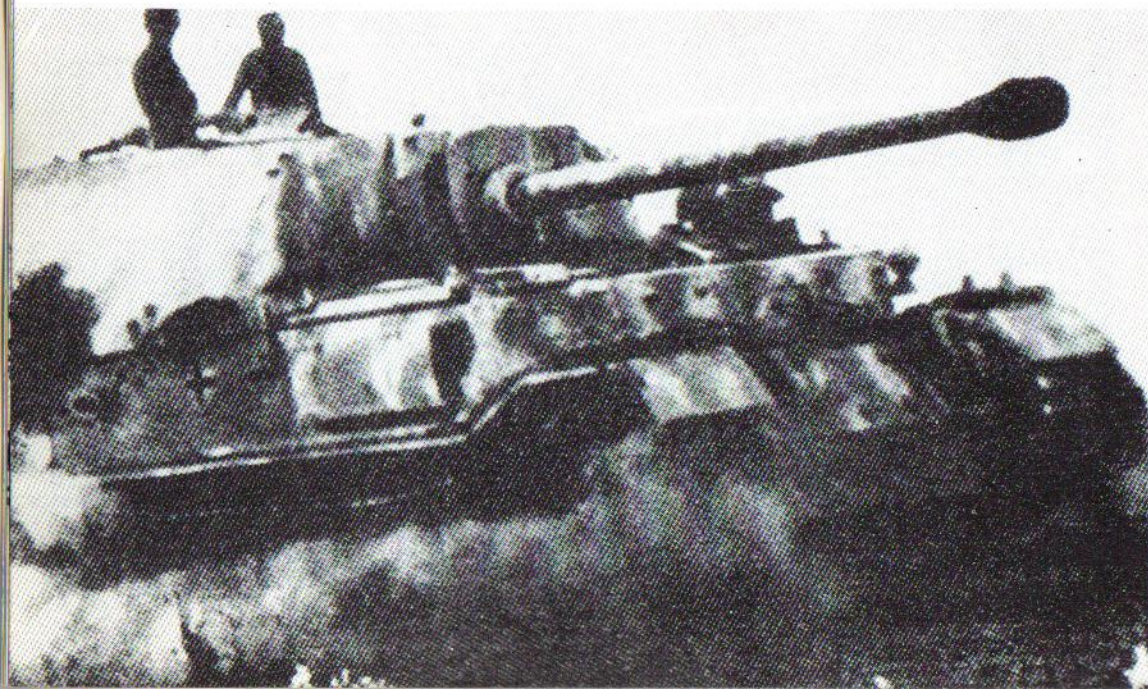

Upper left: In June of 1943 the vehicles were transported by train to the eastern front. Before that, makeshift tube shields were attached. This is the tank of the Company Leader of the 5th Company (Panzerjäger Unit 654).

From the depot where they were unloaded, the vehicles traveled by road to their concentration areas. Numerous technical problems already appeared here.

Opposite page:

A sad end for No.501, which we have seen already. A shot in the left front running gear made this Panzerjäger incapable of moving. The Elefant was then set afire by gunfire and had to be abandoned. Ammunition exploding in the rear compartment blew the rear hatch off. The yellow "N" in front and back was borne by all "Elefants" of Panzerjäger Unit 654 (the commander's initial).

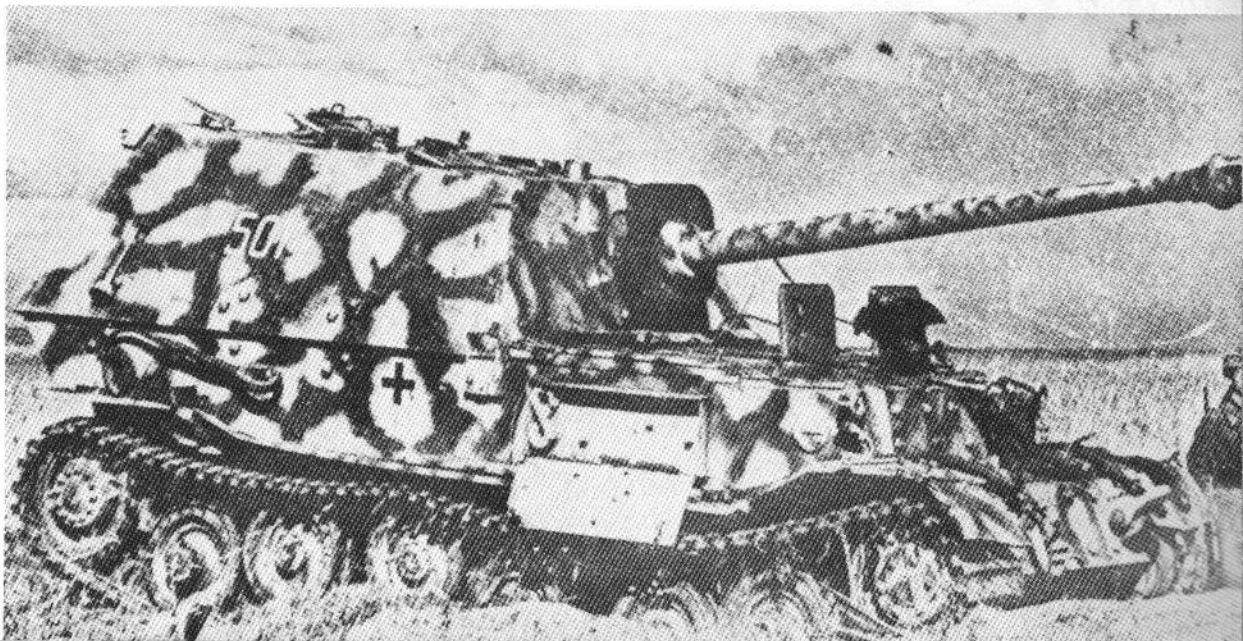
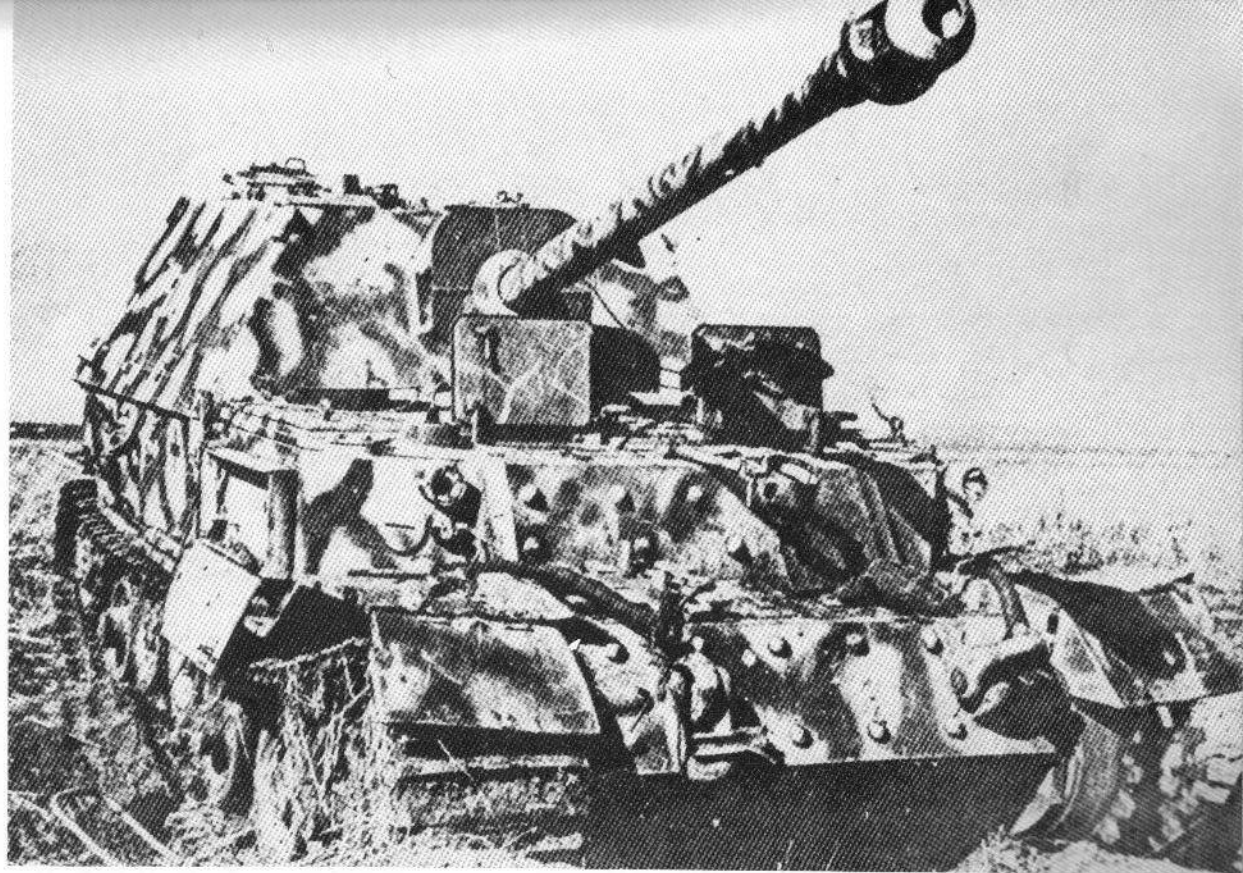
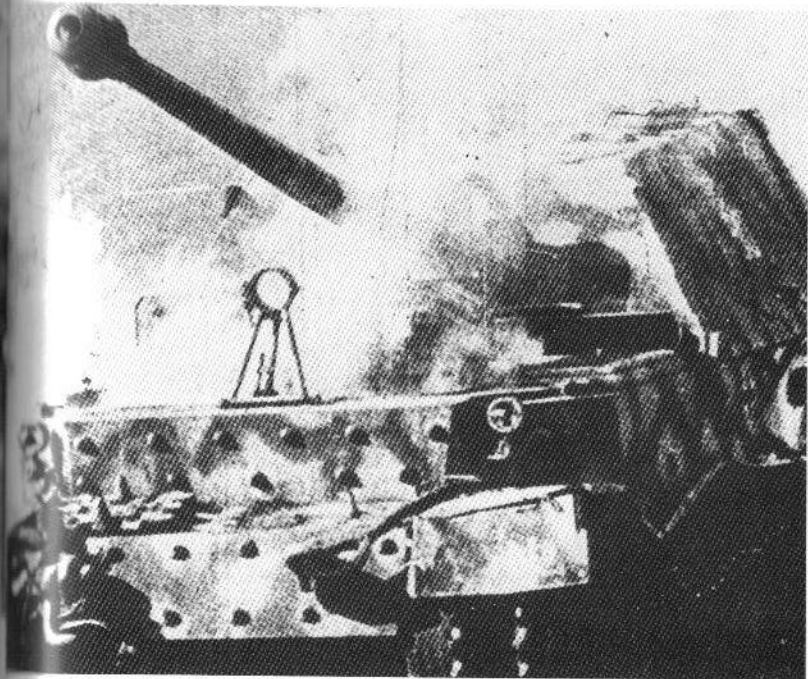

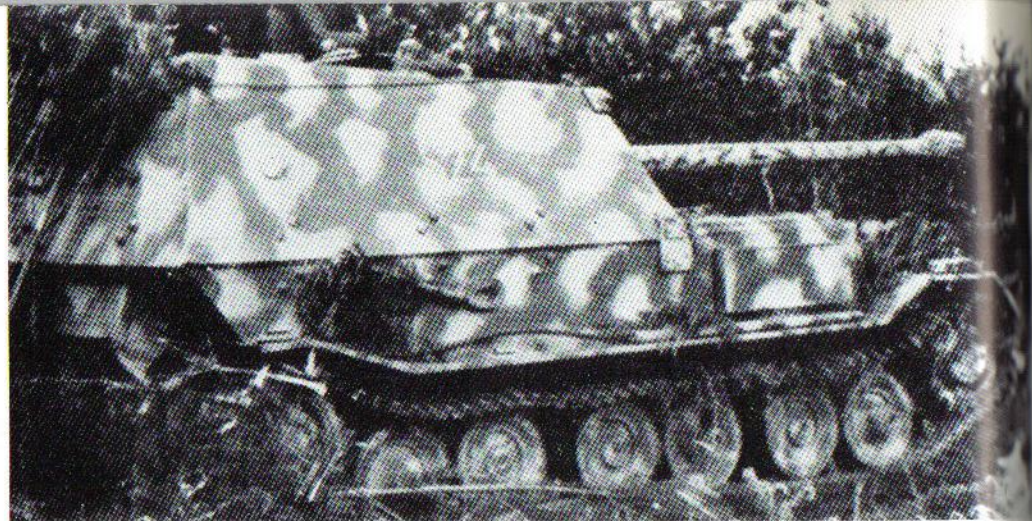

Above: Elephant "624" (second column of the 6th company) is concealed in the brush before "Operation Citadel."

Upper and lower left: Maintenance work on Elephant "612" (first column of the sixth company). The single canister on the engine cover indicates damage to the cooling system.

## ARMAMENT

The primary weapon was the 88mm Pak 43/2 antitank gun with L/71 caliber length (made by Dortmund-Hoerder Hüttenverein of Lippstadt).

The gunner sitting to the left of the weapon aimed it mechanically with the help of a manual elevation and traverse wheel, with a traverse of +/-14 degrees and an elevation from -6 to +14 degrees. The firing height of the 6.3 meter gun with its attached to a folding rack in marching position was 2.31 meters. The weapons system weighed 2265 kp.

Armor-piercing and explosive shells were fired. The 22.8 kp PzGr 39/43 antitank shell, with a velocity of 1000 meters per second, could penetrate 186mm of armor at 1000 meters at a 90-degree angle; the 19.9 kp PzGr 39/43 antitank shell (velocity 1130 meters per second) 233mm. In addition, the 18.6 kp SprGr 43 explosive shell (velocity 750 meters per second) had a theoretical maximum range of 10 kilometers.

The load of ammunition, 55 shells in all, was carried under the gun and along both side walls of the fighting compartment. Two loaders took turns loading.

In addition, the Elephant crew had one MG 34 machine gun with 600 rounds and two MP 38 machine pistols. The 50 Elephants still in action after "Operation Citadel" were prepared for action at the Nibelungen Works. Essential changes were the installation of an MG 34 bow machine gun in a round hatch near the radioman and a commander's cupola in place of the original hatch on the roof.



This destroyed Elefant "723" tells of the bitterness of the fighting that took place here. It was probably abandoned after taking a hit in its running gear and took a series of other hits on the bow, the gun barrel and the top of the turret. The crew defended themselves through the opened close-combat ports. In the end, the vehicle was blown up and abandoned.

## COMBAT HISTORY

One reason for the date of the attack that began "Operation Citadel", the last German offensive operation on the eastern front in the Kursk area, being changed several times was that the new Panther Tank and Elefant Panzerjäger were not yet ready for use. Two Panzerjäger units, 653 (Major Steinwachs) and 654 (Major Noak), were formed and

made parts of Jagdpanzer Regiment 656 (Oberstleutnant von Jungefeldt). Each unit consisted of three companies of four columns (three Elefant tanks each), plus two staff vehicles, for a total of 38. There was also a staff and supply company. Another 14 Panzerjäger (some of them not ready for action yet) were held in reserve.

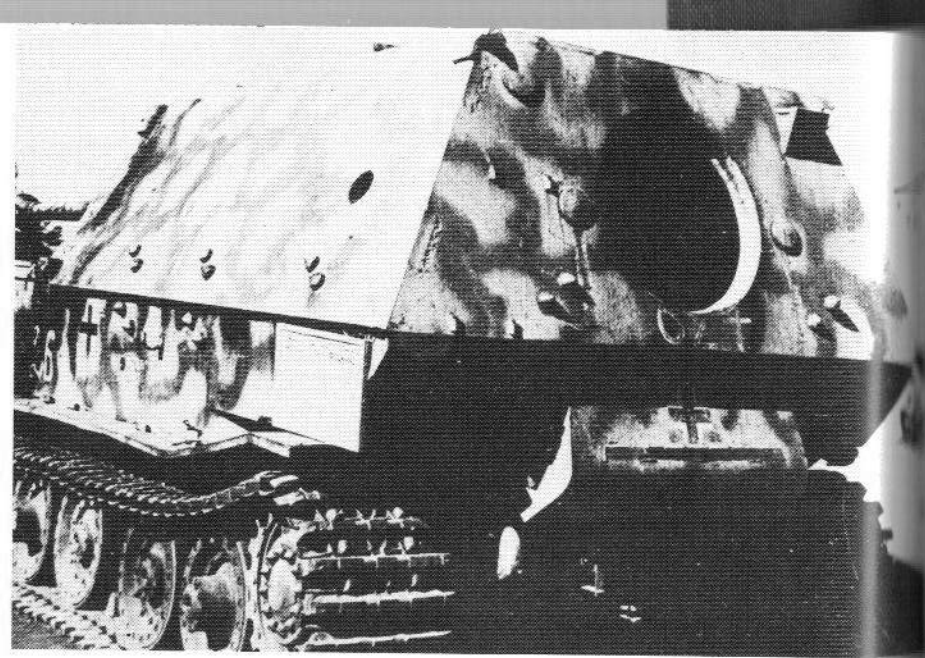
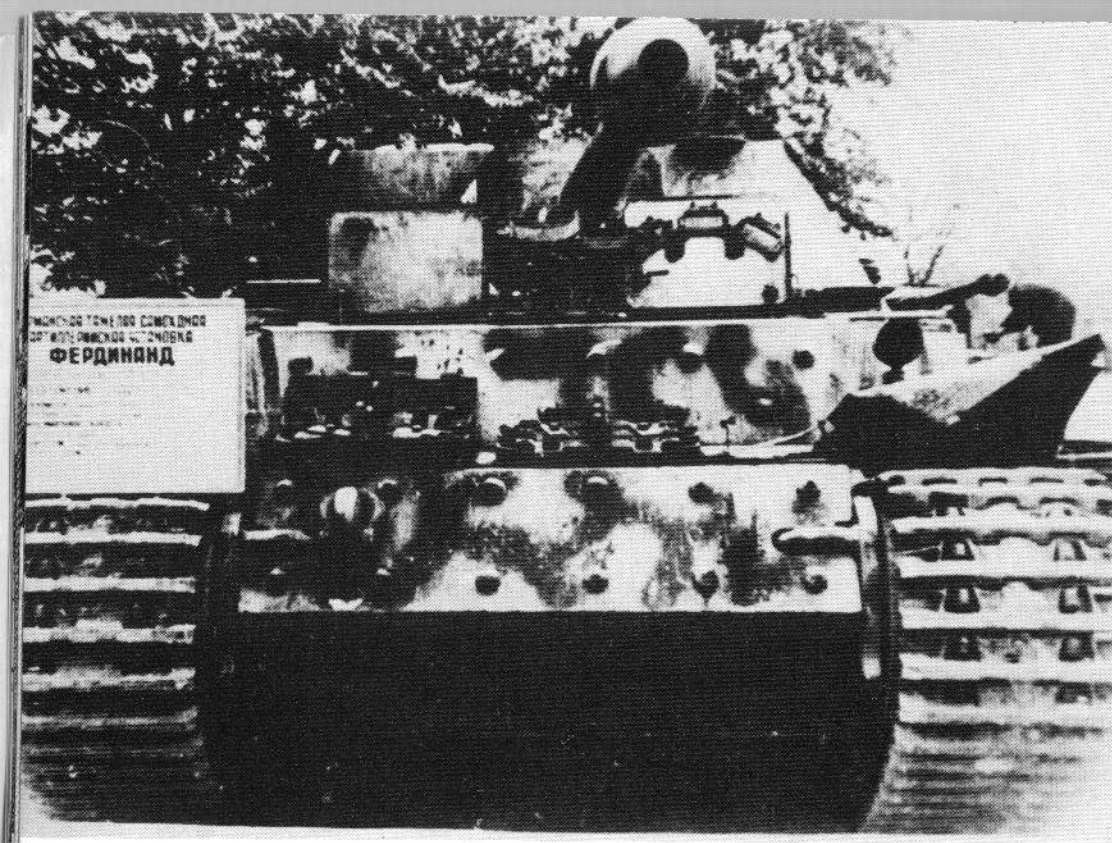

After the end of their victorious battle around the Kursk bulge in the front, the Soviets showed off the enemy vehicles they had captured. All the new weapons systems that had inspired too-great hope were displayed (for example, the Panzer V Tiger), plus the Panzerjäger "Ferdinand" (Elefant). The Elephant at right has damaged running gear. Number 624 was obviously changed during its use at the front, as its original turret number is barely legible.

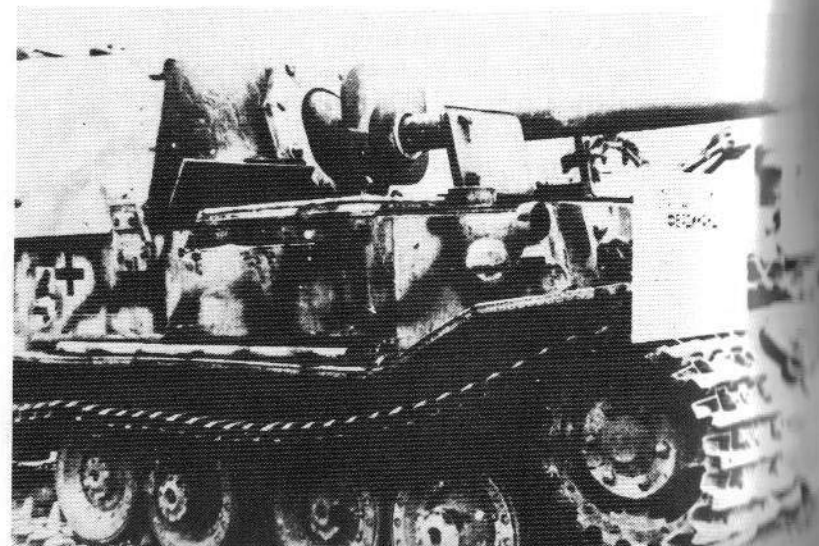
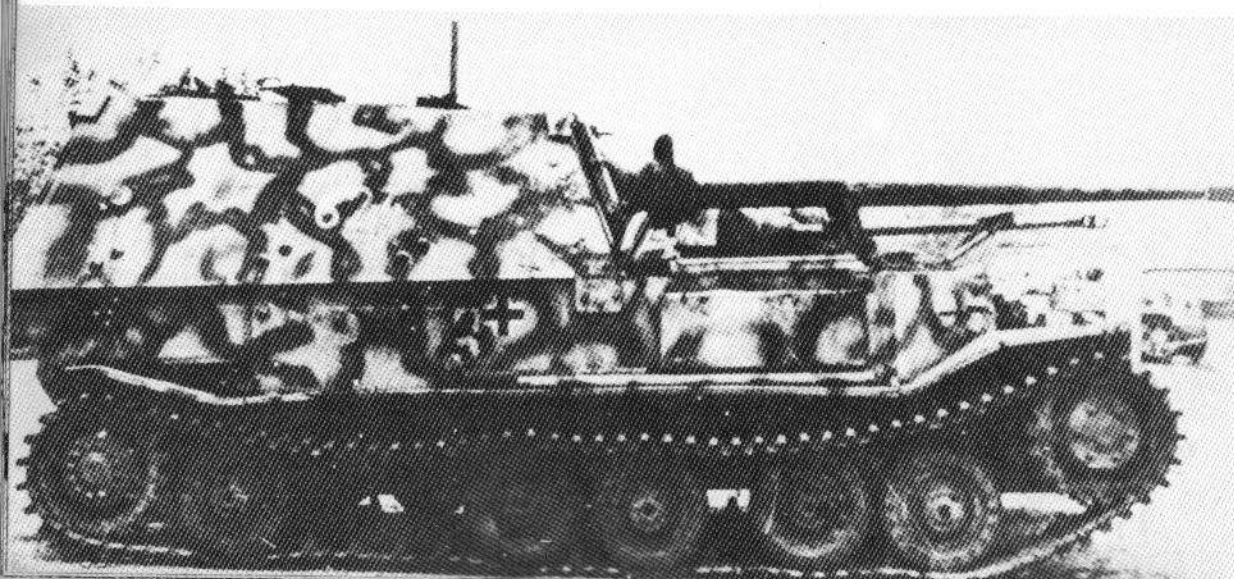

The remaining Elefants were sent back to Germany and overhauled. They were given an urgently needed bow machine gun and a commander's cupola for a better panoramic view. The base of an antenna can be seen at the right front above the bow of the hull.

The regiment saw service with the XXXXI. Panzer Corps on the north wing of the attack force. As of July 27, 1943 the Elefants had destroyed 502 enemy tanks, 20 antitank guns and 100 other guns. But their own losses were high. Other than their limited mobility, the lack of a bow machine gun proved to be a serious weakness. Once separated from the accompanying infantry, many of the Jagdpanzer fell victim to close-combat tank fighters or were left unable to move and had to be abandoned.

Until the end of 1943 what remained of the regiment fought at the Nikopol bridgehead and in the big bend of the Dniepr, destroying more than 200 enemy tanks. In the winter of 1943-44 the rest of the Elefants were sent back to Germany for factory overhauling.

In 1944 only isolated action took place (for example, at Nettuno) in Italy. There what remained of the only units still equipped with the Elefant, the 2./Pz.Jg.Abt.653, was renamed Heavy Panzerjäger Company 614. It ceased to exist at the beginning of 1945.

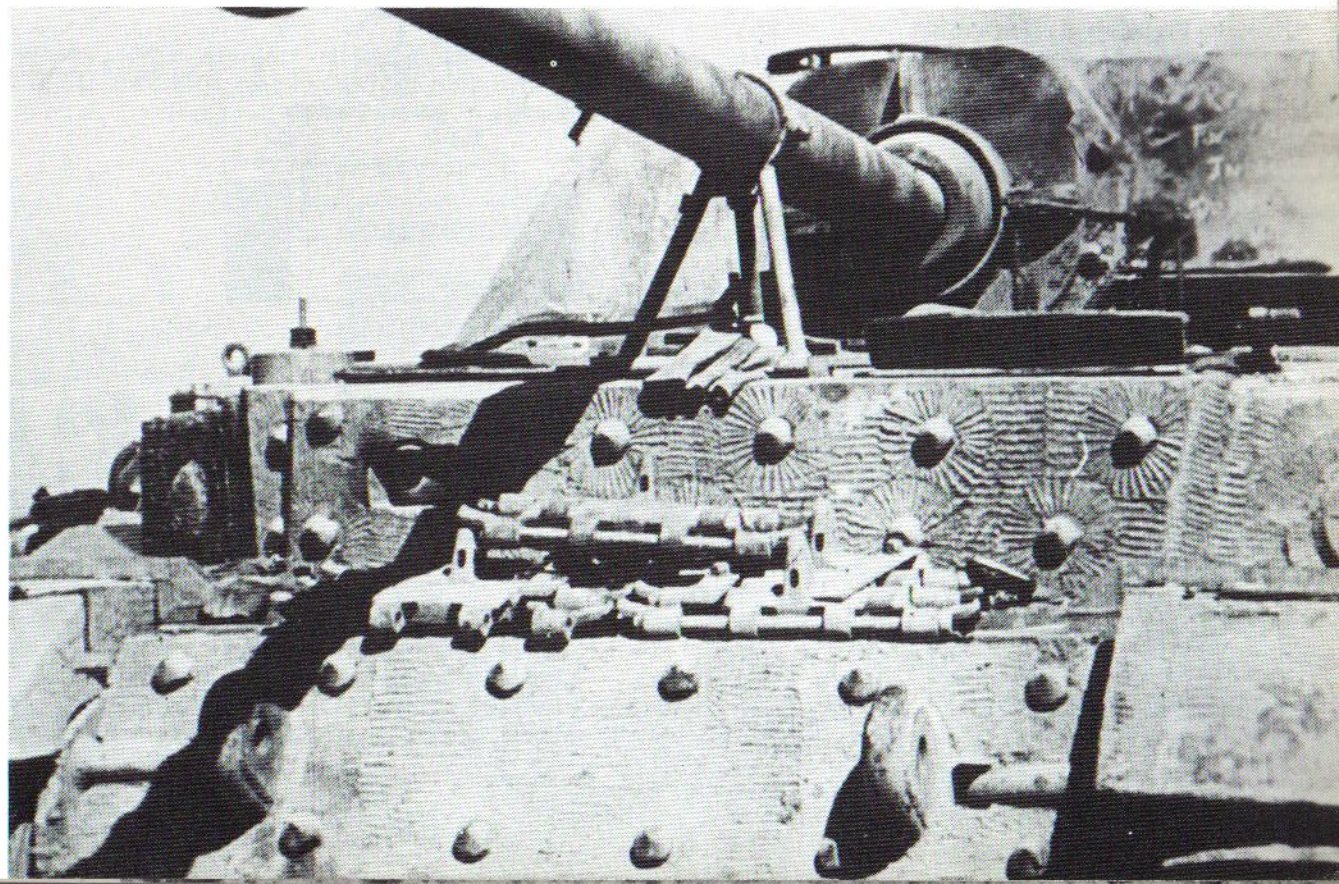

These outline drawings show the Elefant Panzerjäger before (above) and after (below) being overhauled in Germany.

### Technical Data

Data	Elefant
Fighting weight (tons)	65
Length (mm)	8140
Width (mm)	3380
Height (mm)	2970
Horsepower	2 x 265
Fuel capacity (liters)	950
Range (on/off road)	150/90
Top speed (kph)	30
Track (mm)	2680
Road wheel size (mm)	794
Track length (mm)	4175
Track width (mm)	640
Track links	109
Ground clearance (mm)	480
Ground pressure (kp/cc)	1.23
Crew	6
Climbing (degrees)	30
Climbing (mm)	780
Spanning (mm)	2640
Armament	88mm StuK43/1
Caliber length	L/71
Rounds carried	55
Machine gun	1 MG 34
Rounds carried	600

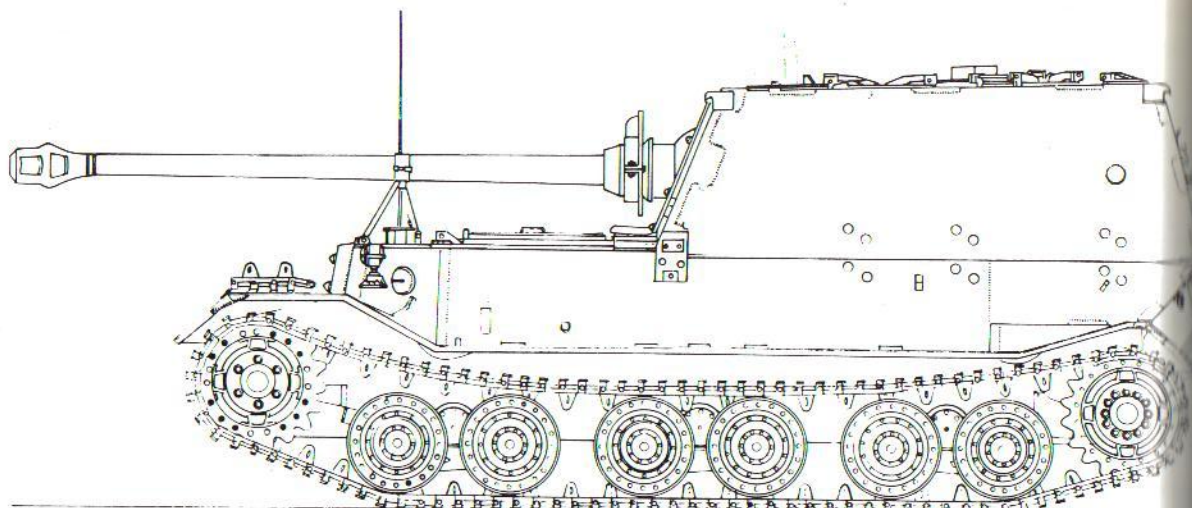

Panzerjäger Tiger (F)

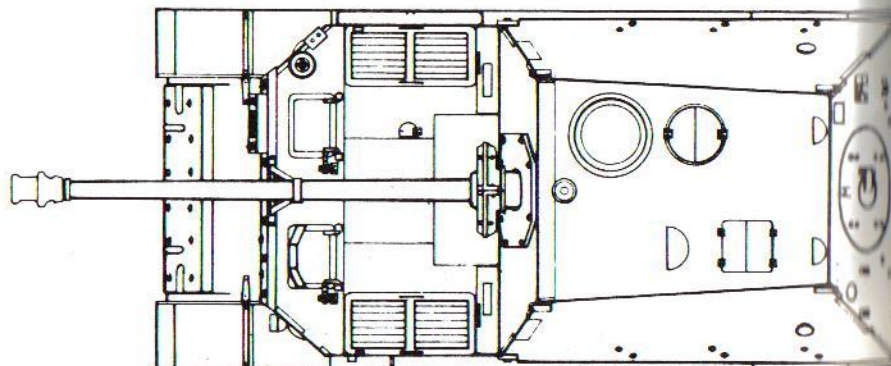
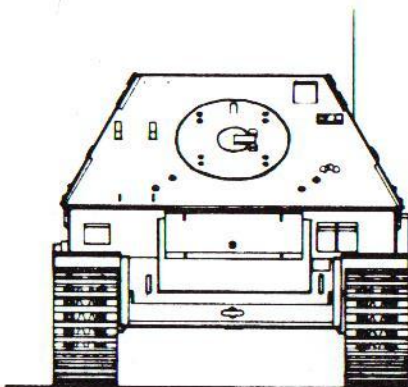
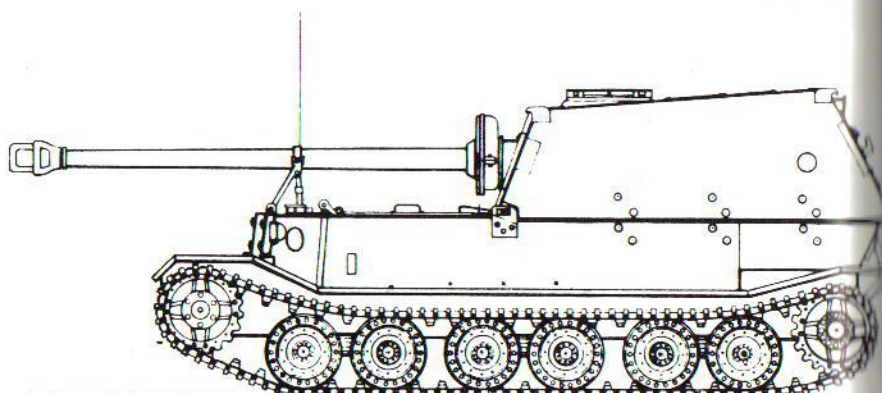
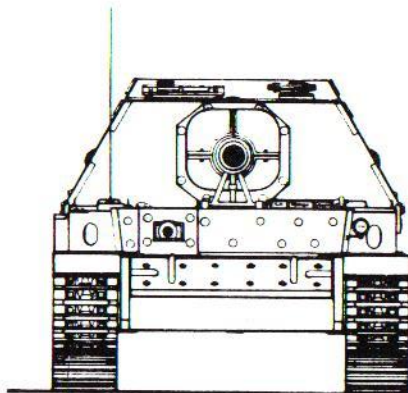





Only in Italy did the Elefant see sporadic, usually scattered service. At upper left an Elefant is seen in service at Nettuno in March of 1944. The other photos show an Elefant in Sariano. This vehicle was blown up by its crew as the Allies advanced on them. Previously they had been trying to repair damage to the running gear. A wheel mount to be replaced lies atop the bow.

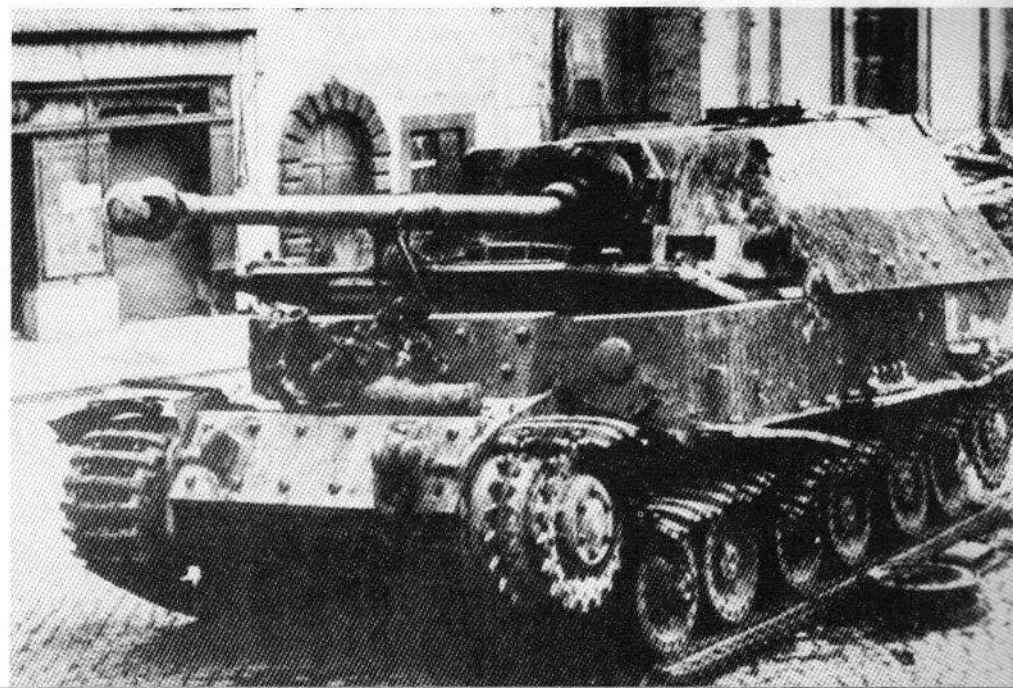

## Panzerjäger Tiger "Jagdtiger"

### DEVELOPMENT

After the success of Assault Gun III as an antitank system, the military leadership tried to utilize chassis of the tanks then in production as tank destroyers by installing large-caliber guns.

As early as the spring of 1942 the request was made by the Army General Staff to utilize 128mm guns on self-propelled mounts, not so much as pure tank destroyers, but rather as penetrating support weapons for the infantry. On May 18, 1942 Hitler had ordered the Weapons Office to prepare a rifled antitank gun of 128mm caliber. The firing statistics showed a very favorable percentage of hits, and lower-caliber (88 and 105mm) heavy shells were also tested.

Early in 1943 it was planned to build a 128mm gun on a Panther or Tiger chassis as a "heavy assault gun" (KTB OKW/Org.Abt. III of March 21, 1943), whereby the Panther chassis, once a wooden mockup had been built, was finally found to be unsuitable.

The wooden mockup of the Jagdtiger (Hunting Tiger) was presented in Arys, East Prussia on October 20, 1943 as a sort of preview. The first production vehicle was introduced at Kummersdorf on April 6, 1944.

During a discussion with Hitler on October 12, 1944 it was suggested producing a series of 150 Jagdtiger, with 30 gun barrels per month produced for them at first. The other 128mm guns were mounted on captured Russian or French chassis and used in the rifled version. On January 5, 1945 Hitler decreed that, above and beyond the originally planned series of 150, more should be produced. But the crucial problem that hindered series production was a shortage of 128mm gun barrels. On

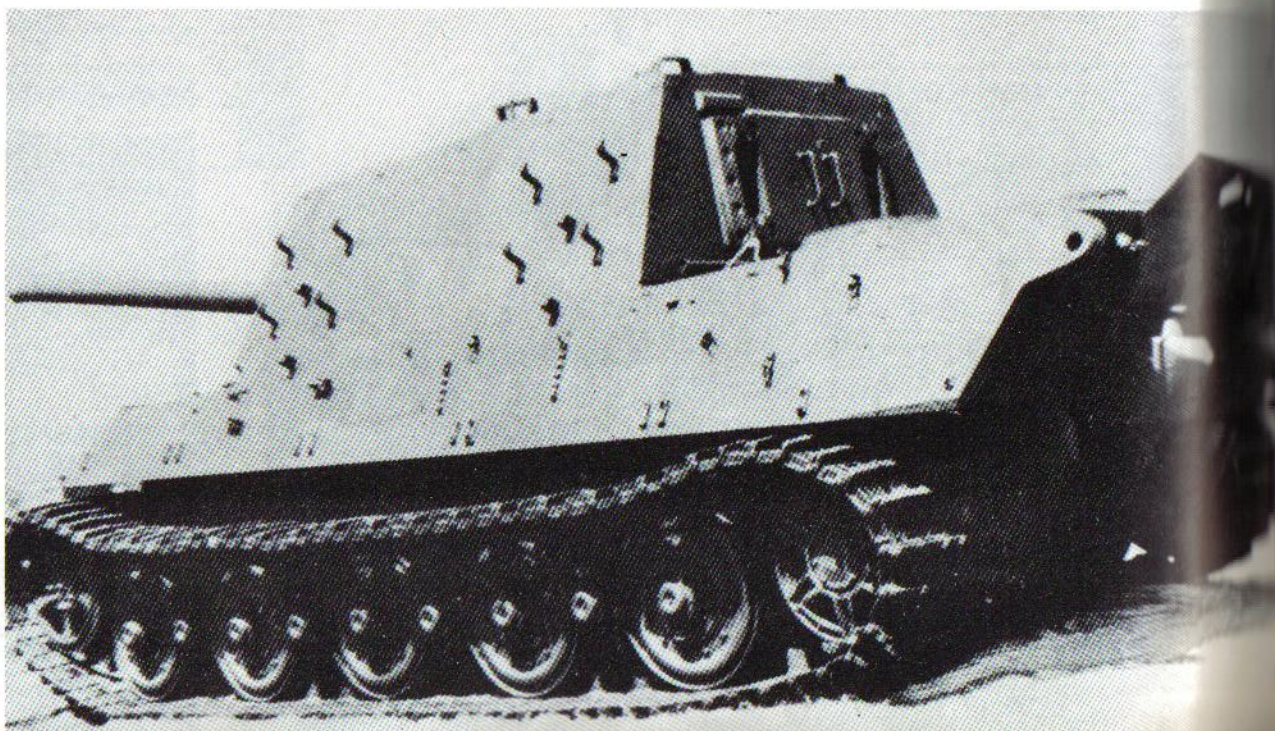

February 26, 1945 (Speer Protocols) Hitler ordered "extreme measures" taken to increase Jagdtiger production and determine in what ways additional 128mm weapon systems — including the rifled version — could be expedited. As a makeshift solution, the 88mm Pak 43/3 antitank gun was to be installed temporarily. The Hallesche Maschinenfabrik of Lippstadt modified the 88mm Pak appropriately (Pak 43/3, Version D) and delivered them to the Nibelungen Works, where Jagdtiger assembly had begun at the beginning of 1944.

This work came to a standstill after the first two vehicles were completed in the spring, and recommenced unsteadily in July of 1944. Energy and transport difficulties as well as the effect of air raids made the planned monthly goal of 50 units impossible; usually fewer than 20 left the Steyr-Daimler-Puch production facilities in St. Valentin.

At the end of February 1945 production was broken off after 74 Jagdtiger units had been built. (The chassis numbers begin with 305001.)

How many of these tank chasers were armed with the 88mm antitank gun is not known.

Above: Jagdtiger production at the Nibelungen Works. The vehicle in front (No. 54) is nearing completion.

Right: Like all other armament facilities, the site of Jagdtiger production was also the target of numerous air attacks, which interrupted production at times. Here a vehicle damaged by a near miss is shown.

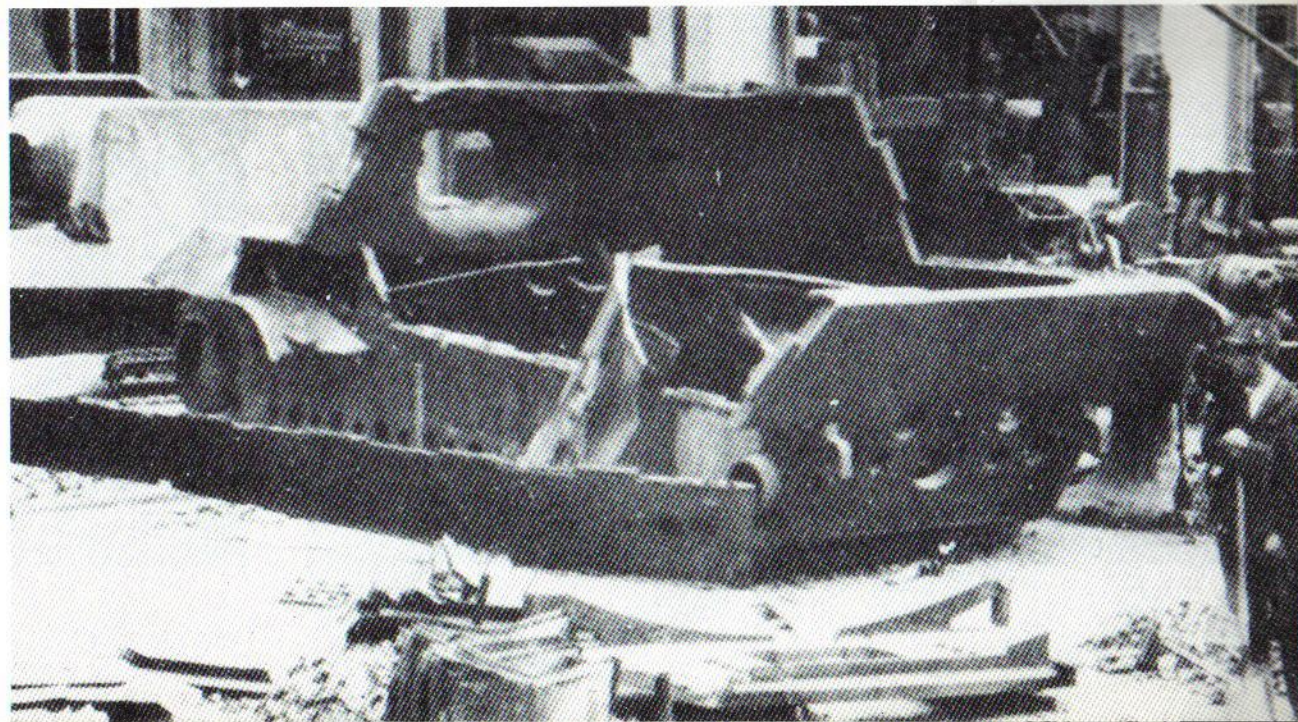
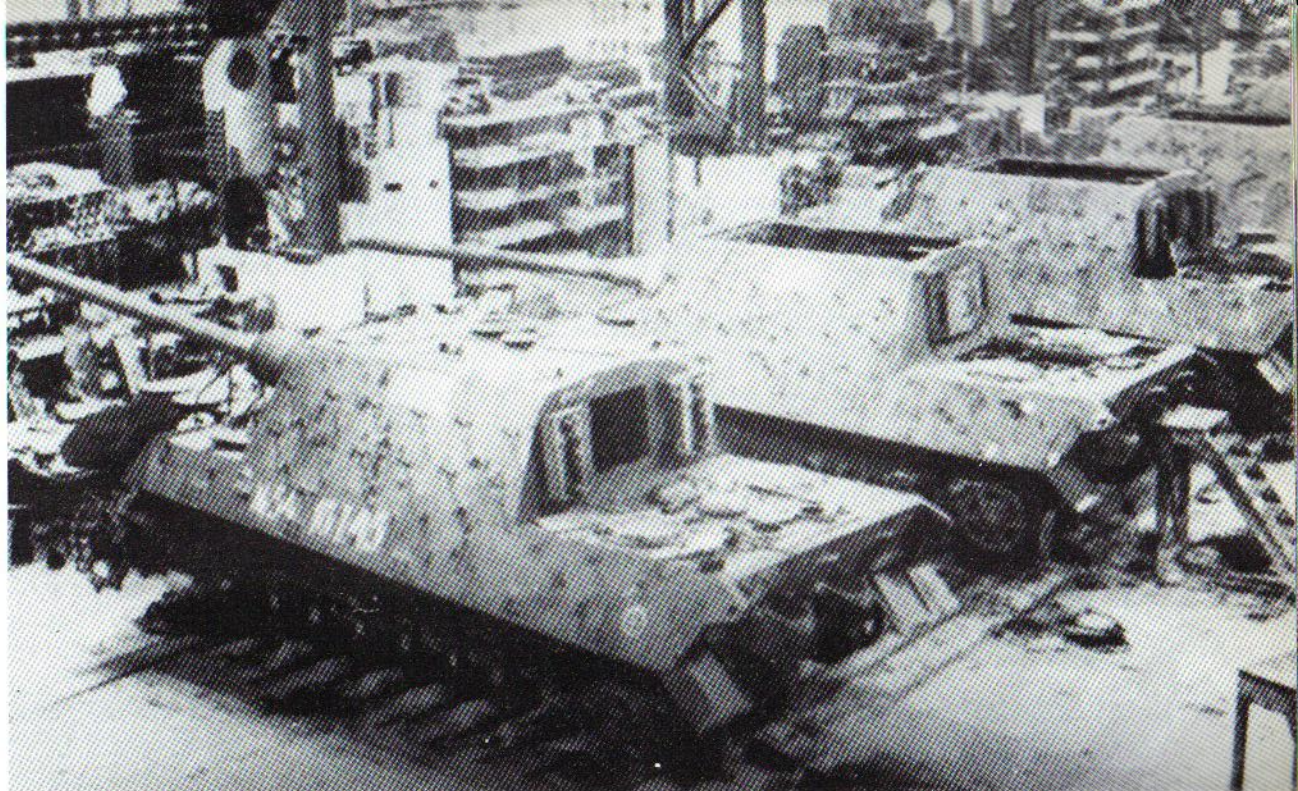

## HULL AND SUPERSTRUCTURE

During the developmental work on the Tiger B, the design for the Tiger assault gun was begun at Henschel in cooperation with Krupp.

The Tiger B chassis had to be lengthened by 260mm for the purpose. The solid tank body was produced by the Oberdonau Iron Works in Linz and had 80mm armor on the sides and rear. The front wall with integrated hatches was made of cast steel with a thickness of 250mm, with a 75-deg Bochumer Verein Friedrich Krupp AG of Essen, and Oberhütten of Malplane. At the rear of the superstructure was an integrated two-section gas-tight tank door.

Major changes were necessary for modification and storage of the two-part 128mm ammunition.

The roof of the fighting compartment was formed by a 40mm steel plate that was bolted on. On the right side of it was the commander's cupola, and in front of it — laterally movable — was the commander's periscope with a flap in front for the lowerable stereo-telescope. In addition, the commander had a periscope pointing to the right. There were two more periscopes at the rear of the fighting compartment roof, giving views diagonally to the left and right. For the gunner, who sat to the left of the gun, there was a kidney-shaped port on the left side of the turret roof with an opening through

which the end of the aiming telescope projected. Behind it was a periscope pointing forward. In between was the closeable port for the smokelayer, which was operated from inside. In the middle of the roof was the ventilation cupola.

The other details of the hull forward and aft of the engine compartment were like those of the Tiger II tank.

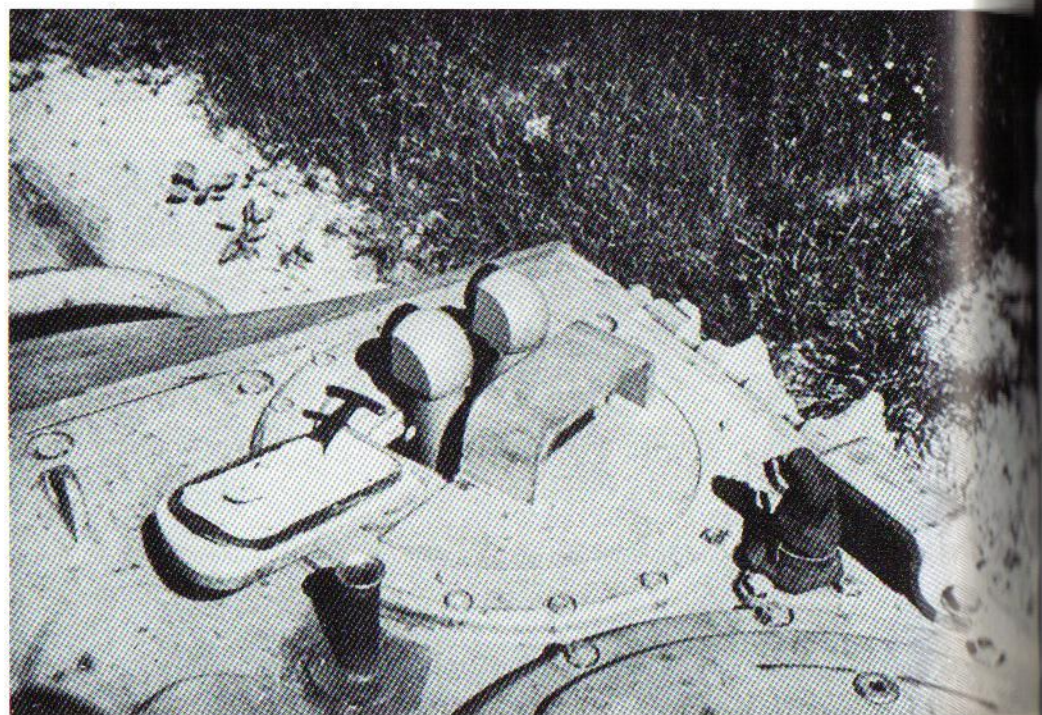
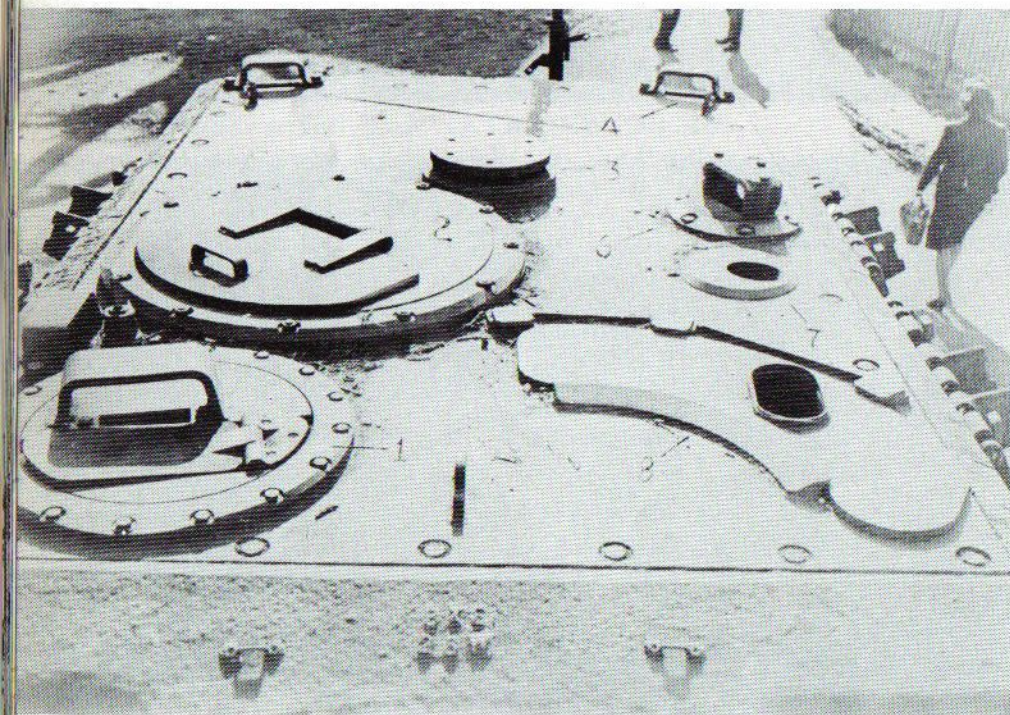

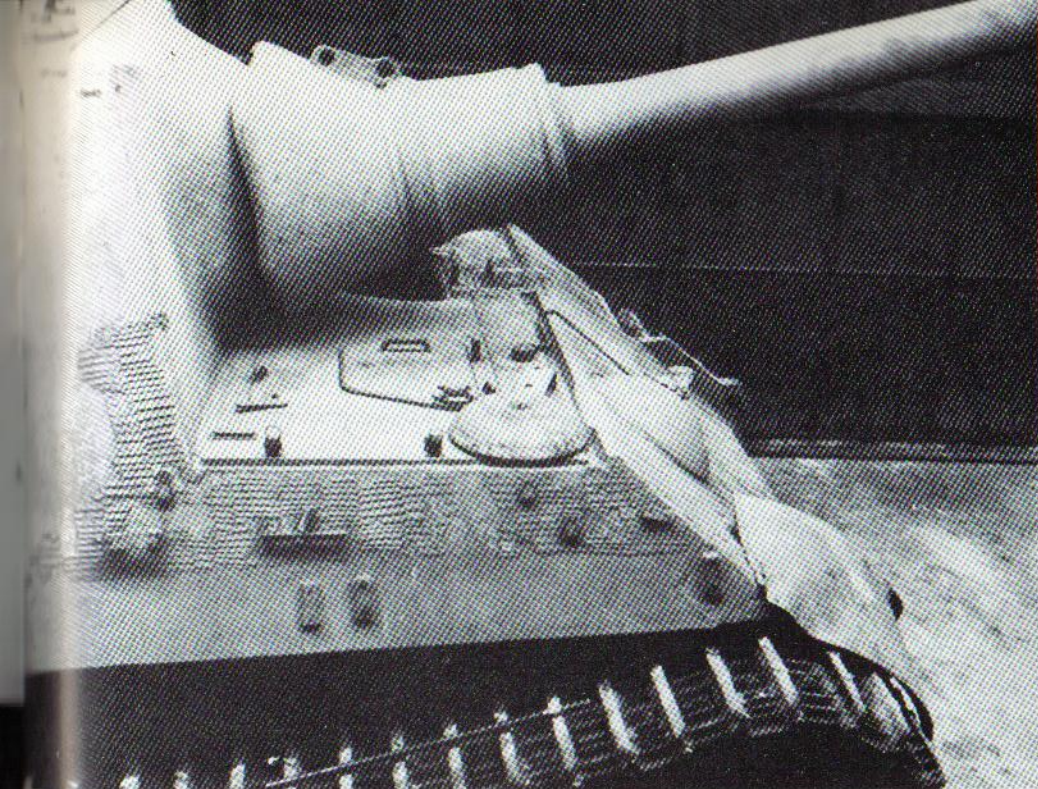

Above: The front shows the well-formed mount of the 128mm antitank gun. In the foreground is the radioman's hatch with the round cover of the bow machine gun ahead of it and the opened driver's port behind.

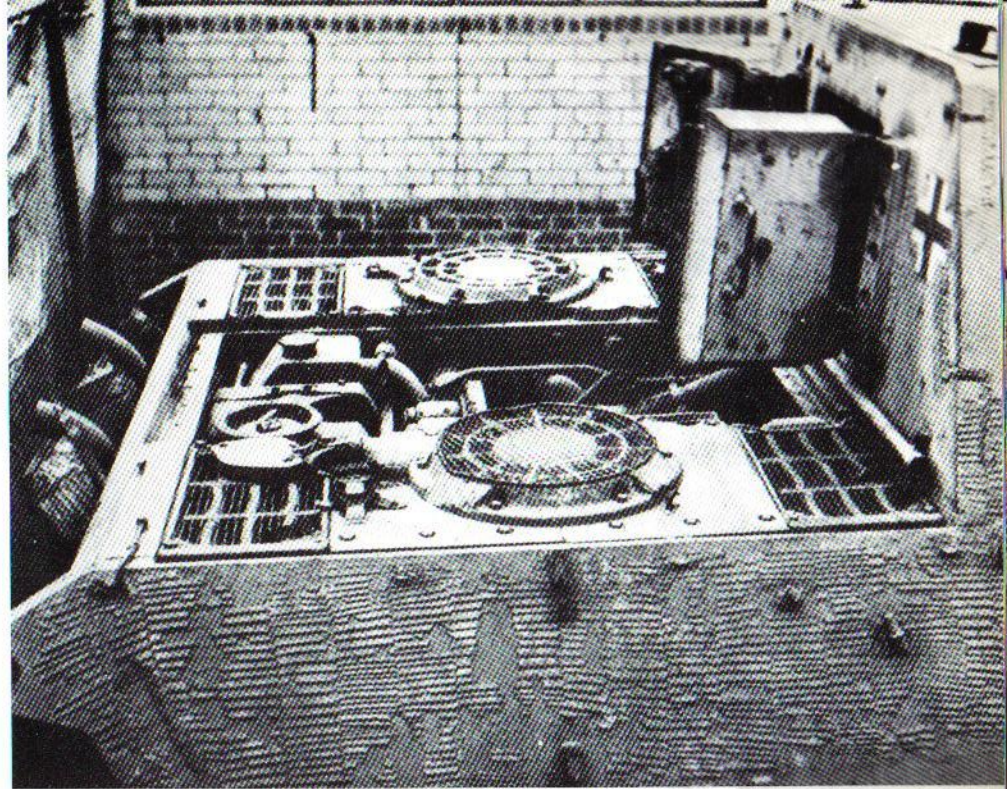

Upper right: The engine compartment with its cover raised. In the left foreground is the fuel filler, with the radiator cover in front of it.

Right: This rear view shows the two ventilation grilles. The two mushroom-shaped objects in the middle are the engine room ventilators. In the foreground are the fuel and coolant fillers.

Opposite page, left: This view of the turret roof shows the large commander's hatch, the kidney-shaped port for the (not installed) aiming telescope at the left front, and the ventilation cupola in the middle. At the right front is the turning periscope for the commander.

Opposite page, right: Detailed view of the turning periscope. In front of it, the stereo-telescope was extended for range finding through the hatch opened from inside.

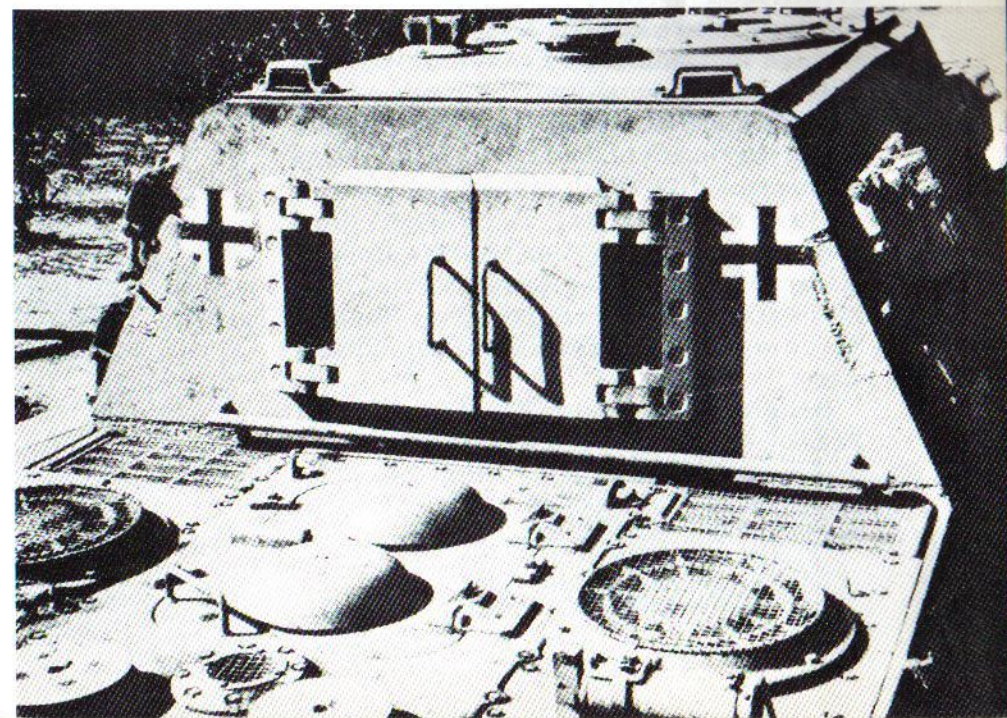

## ARMAMENT

The 128mm gun originated from a request made by the Army General Staff in the spring of 1942. Krupp was given the job of developing it, and the planned delivery date was the summer of 1943.

On May 15, 1942 this developmental work was defined more precisely as commanded by the Führer and simultaneously placed on a broader basis, since Rheinmetall-Borsig of Düsseldorf and the firm of A. G. (formerly Skoda) were put under contract in addition to Krupp. A range of 21 kilometers was called for, and the weight in firing position was not to exceed 6.5 tons. A 360-degree traverse for the antitank gun was required.

Thus the 128mm gun was originally planned not as an antitank gun, but rather as an artillery cannon.

The first 128mm gun was displayed on August 16-17, 1944, mounted on a captured Soviet 152mm M 37 433 (r) mount. Later the French mount of the 155mm GBF-T Cannon 419 (f) was also used. The development of this weapon had nothing in common with the failed attempt to mount the barrel of the 128mm Flak 40 anti-aircraft gun on two prototype chassis of the Tiger (VK 3001 H) as an antitank gun. (Both of these were lost on the eastern front.)

About 160 of the 128mm antitank guns were made; the Rheinmetall version existed only in several prototype examples, while the Skoda version was rejected in the planning stages.

Designated the 128mm Pak 44 L/55 (later Pak 80), this gun was intended to be installed in the Tiger B chassis. Production took place at the Berta Works of the Krupp firm in Breslau.

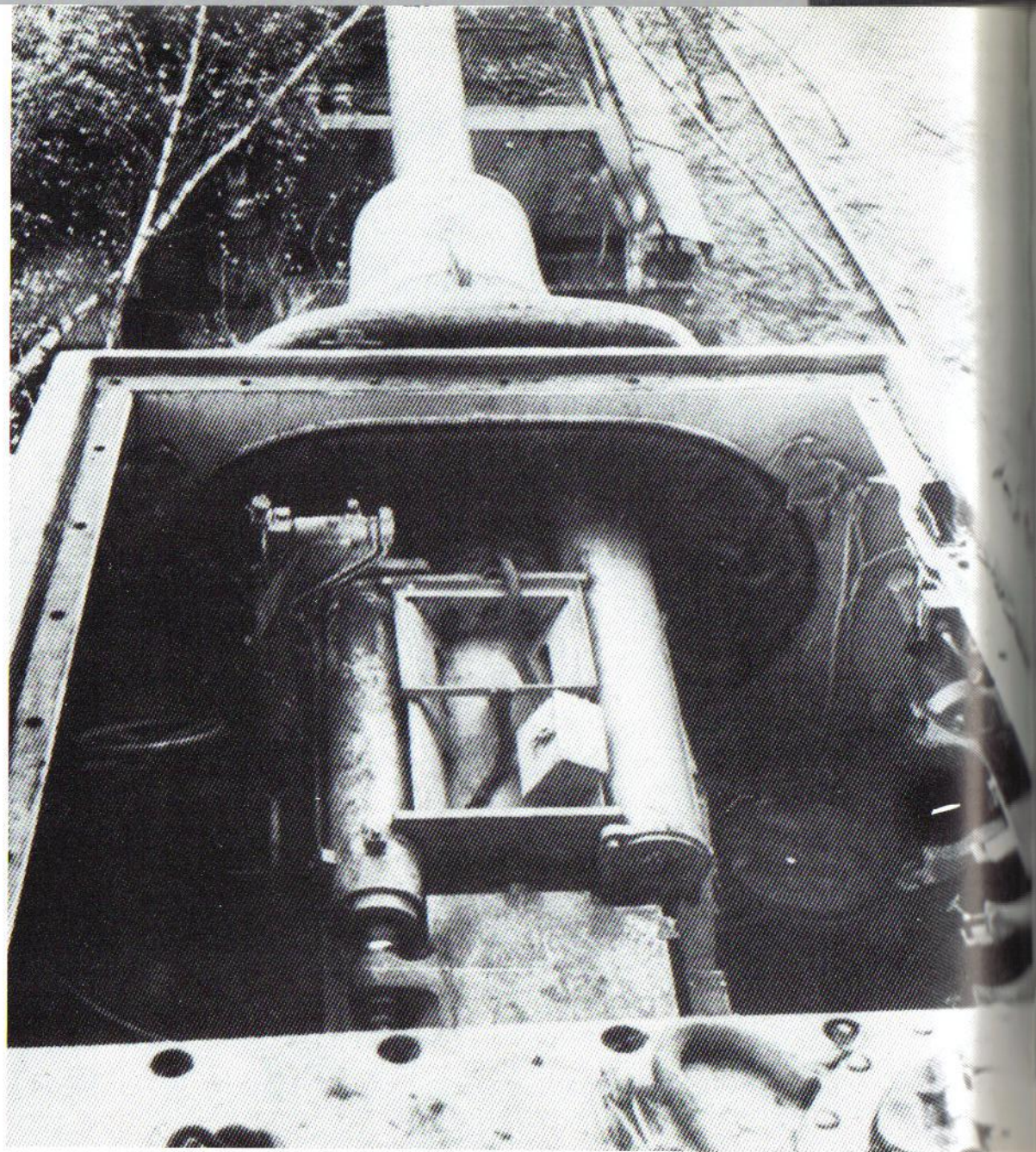

Above:

The interior of the fighting compartment, photographed after the removal of the turret cover. At the left above the 128mm antitank gun is one of the barrel brakes, at right the barrel extender. At the left is the handwheel for traverse aiming.

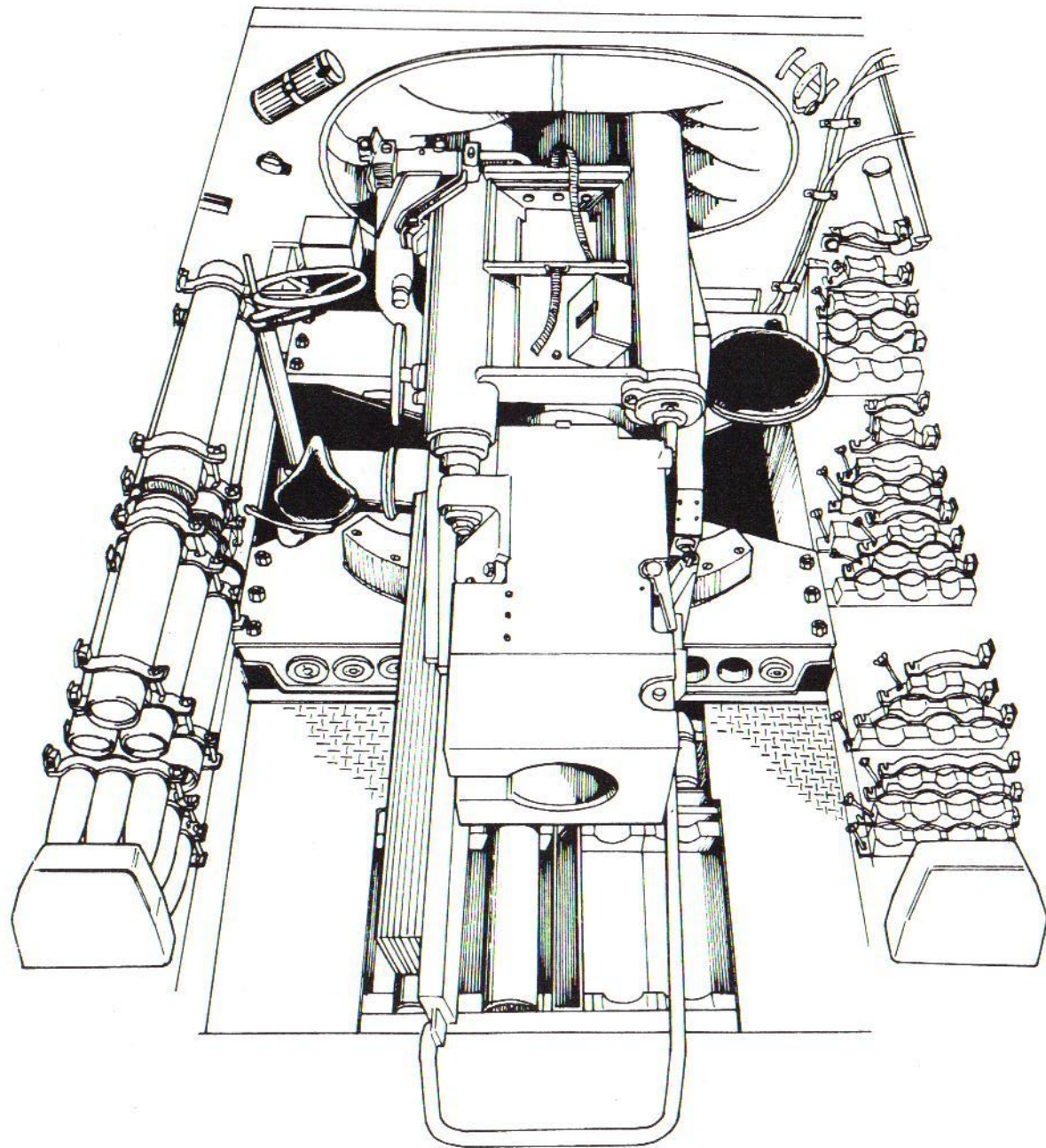

Interior construction of the Jagdtiger with the racks that held the two-piece ammunition on the sides of the turret and under the gun. Forward on the left is the gunner's seat, and at the right is the commander's seat.

Unlike the 128mm anti-aircraft gun, the 128mm Pak 80 had a (one-piece) complete barrel with a length of 7.02 meters (6.61 meters rifled), weighing 2.2 tons. The base with the shearing handle-flat wedge breech (192 kp) weighed 1.1 tons. The two-piece ammunition was loaded by two loaders, with the propelling charge in a sheet-metal cover, and during the loading process the base of this cover released the holding grips of the breech, thus closing them. Ignition was achieved by means of an electrically operated bolt. With the mount and hatch components, the installed antitank gun weighed 7 tons in all.

To the left of the gun, the gunner operated the elevation and traverse aiming mechanism by means of (geared) handwheels. The arc of elevation went from -7 to +15 degrees, and the traverse was +/-10 degrees.

Since the overhang of the Pak 80 tended to swing strongly, especially when in motion, an interior barrel support was installed. A supporting hook was folded up at the rear of the lower mount and hooked into the breech of the gun. During preparation for combat, the hook could be disengaged easily. An external support on the bow of the vehicle was also used.

For (direct) aiming a WZF 2/1 with ten-power magnification and a seven-degree field of vision was used. The angle of elevation control had an adjustable range of zero to 4000 meters for the PzGr 43 and zero to 8000 meters for the SpGr L/50.

027 86805385E



The 28.3 kp antitank shell, with a velocity of 920 meters per second, had a penetrating power of more than 150mm at 1000 meters. The 28 kp explosive shell, with a velocity of 750 meters per second, had a range of 12.2 kilometers; its explosive charge weighed 3.6 kp. The propellant charges weighed 15 and 12.2 kp respectively; the propellant shells 11.6 kp.

The ammunition was stored on the floor and side walls of the fighting compartment. The secondary weapon was an MG 34 machine gun, mounted in a round mantelet in the bow.

## RUNNING GEAR

The running gear of the Jagdtiger was like that of the Tiger II (transverse torsion bars, box running gear) with nine swinging arm locations on each side. Lengthening the hull allowed the drive wheel to be set farther back, and the length of the tracks increased from 4.12 to 4.24 meters. Despite that, the ground pressure — because of the fighting weight having increased by 5.4 tons - increased from 1.02 to 1.06 kp/cc, so that, as with the Tiger I and II, off-road mobility was sharply limited.

Two of the Jagdtiger (chassis 1 and 4) were

equipped with the Porsche running gear, already described for the Elefant. Here four units (of two road wheels each) were mounted on each side. Porsche promised a hull preparation time about 1/3 shorter than Henschel's, with corresponding savings in time. There were also decisive maintenance savings. But series production never took place, and only ten Tiger II chassis were equipped with Porsche running gear.

Rear view of the Jagdtiger. The two-part rear door, the two exhaust pipes and the large projection of the wide tracks are its identifying marks. The baffle over the exhaust pipes was added later to prevent hot exhaust gases from being sucked in through the ventilators.

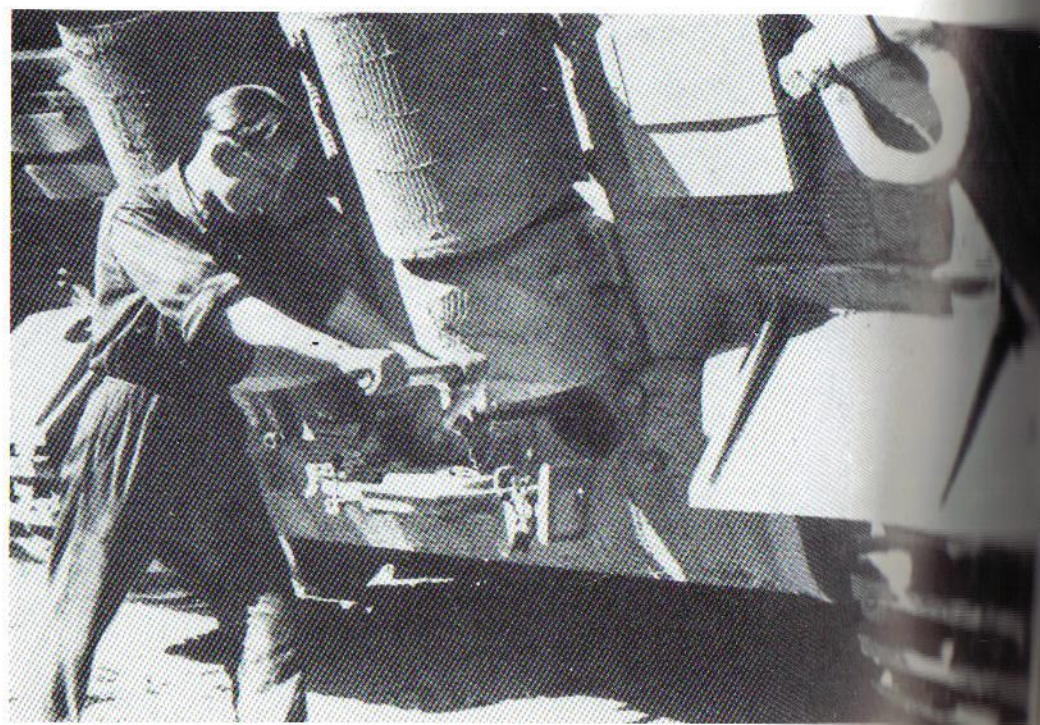

Activating the starter with a hand crane. Underneath, lying horizontally in its rack, is the road-wheel jack.

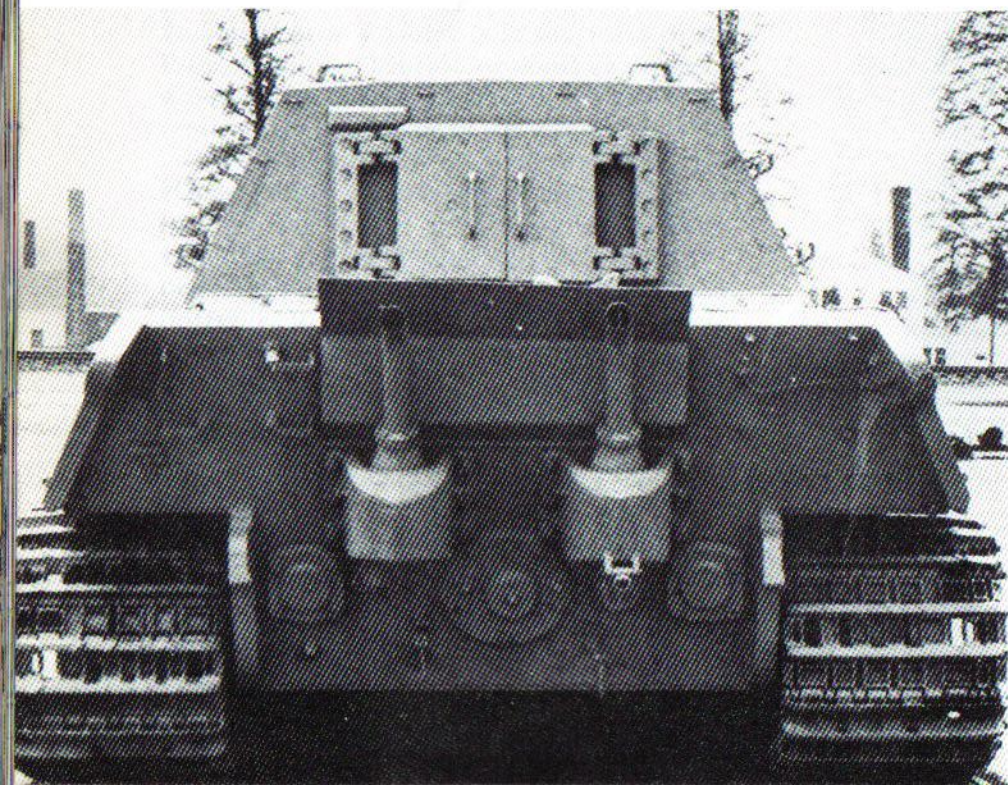



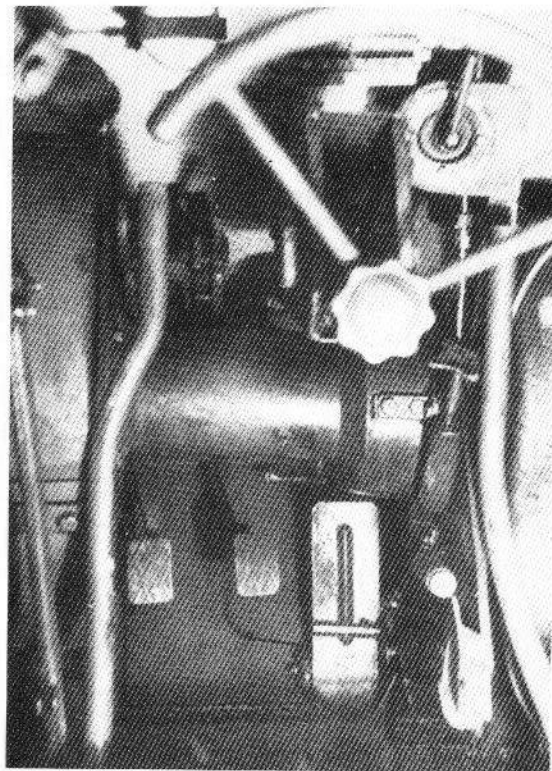
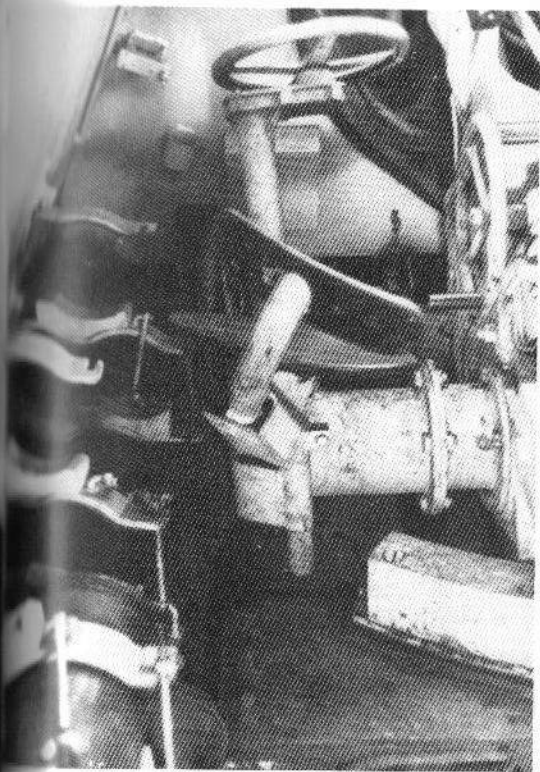

Above: the gunner's seat with the (horizontal) traverse aiming wheel and the elevation aiming wheel at the right.

Upper right: The view from the driver's seat showing the quarter-round steering wheel and the two brake levers.

Right: The commander's seat with the extending stereo-telescope. At right is a directional command signal for the driver (right and left signifying forward and reverse).

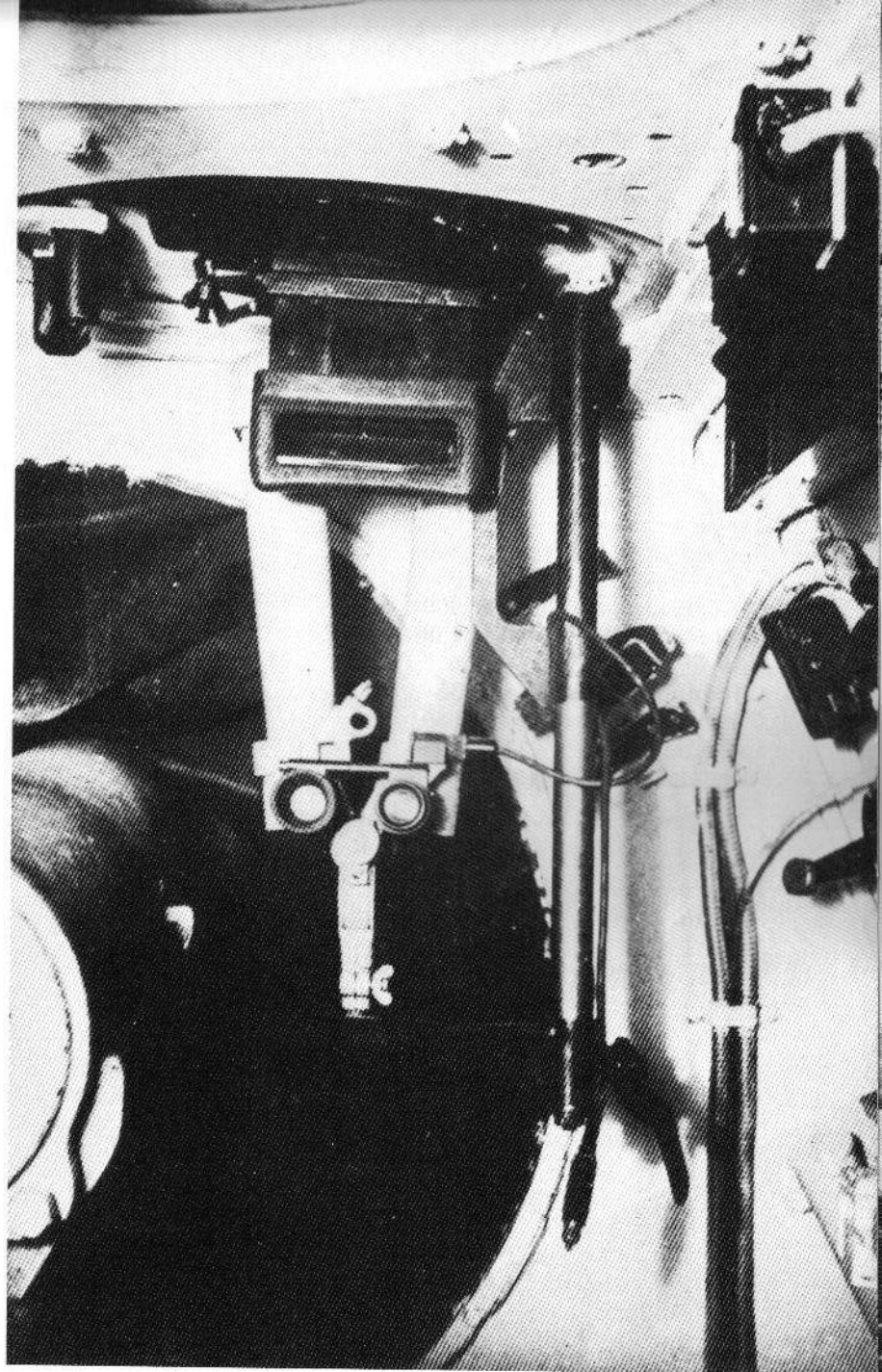

## Technical Data

Data	Jagdtiger
Fighting weight (tons)	75.2
Length (mm)	10,654
Width (mm)	3625
Height (mm)	2945
Horsepower	700
Fuel capacity (liters)	860
Range (on/off road)	110.80
Top speed (kph)	41.5
Track (mm)	2790
Road wheel size (mm)	800
Track length (mm)	4240
Track width (mm)	800
Track links	95
Ground clearance (mm)	460
Ground pressure (kp/cc)	1.06
Crew	6
Climbing (degrees)	35
Climbing (mm)	880
Spanning (mm)	2500
Armament	128mm Pak44
Caliber length	L/55
Rounds carried	40
Machine gun	one MG 34
Rounds carried	1500

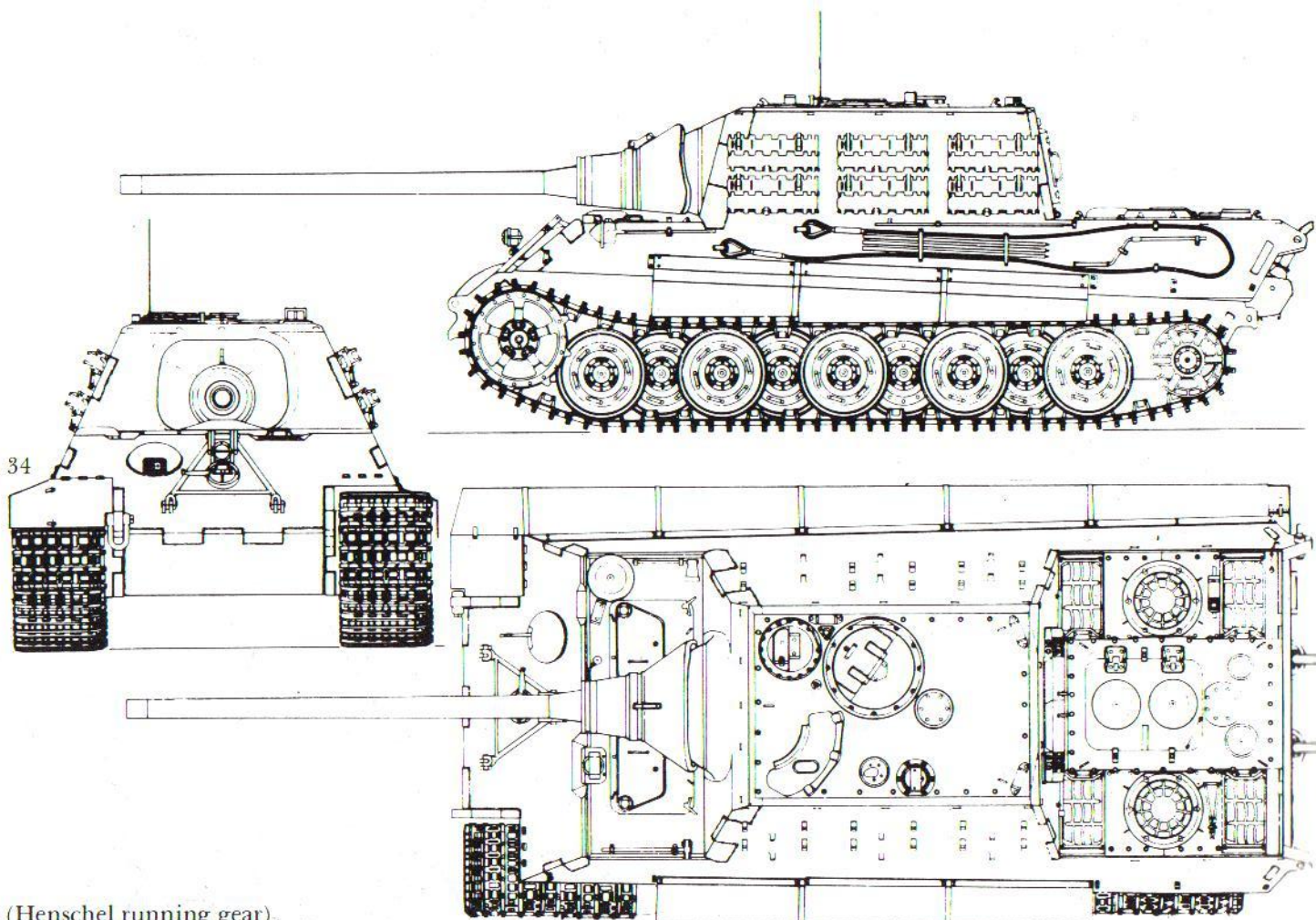

Three-way drawing of the Jagdtiger (Henschel running gear).

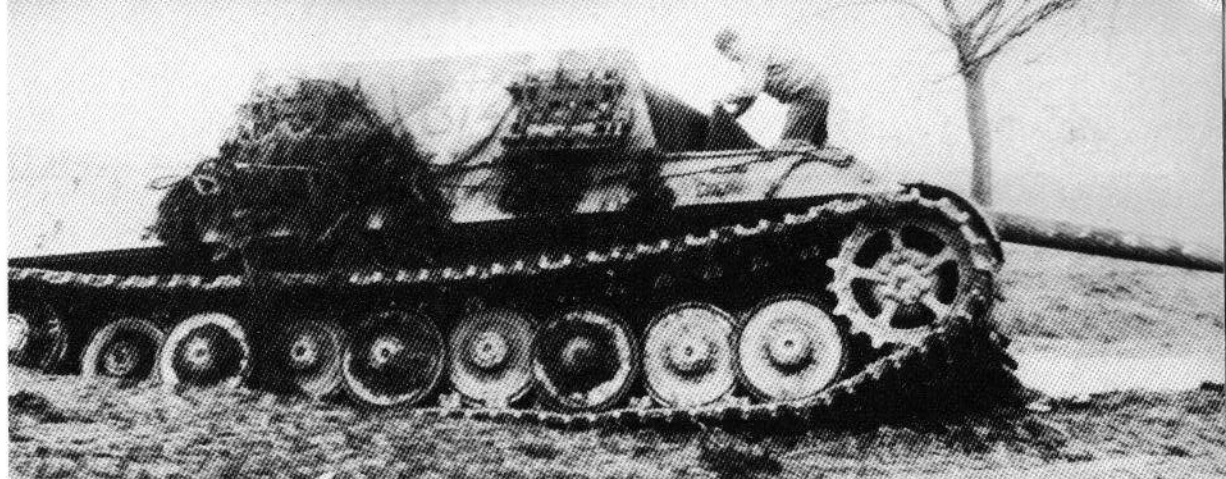
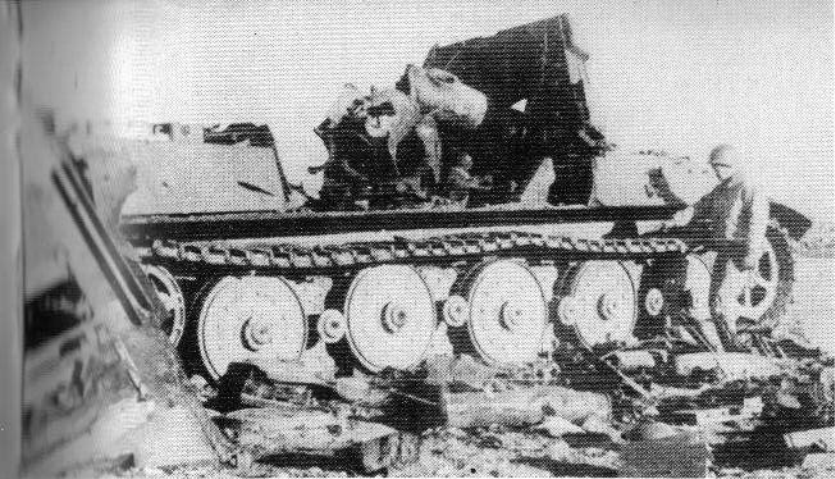

Photos of the Jagdtiger in action in Alsace with Panzerjäger Unit 653. At the upper right is one of the rare Jagdtigers with Porsche running gear, stuck in a ditch near Morsbronn in March of 1945. The other pictures show a vehicle near Rimling that was put out of commission by an M 36 tank destroyer of the 776th (US) Tank Destroyer Battalion and then obviously blown up by its crew.

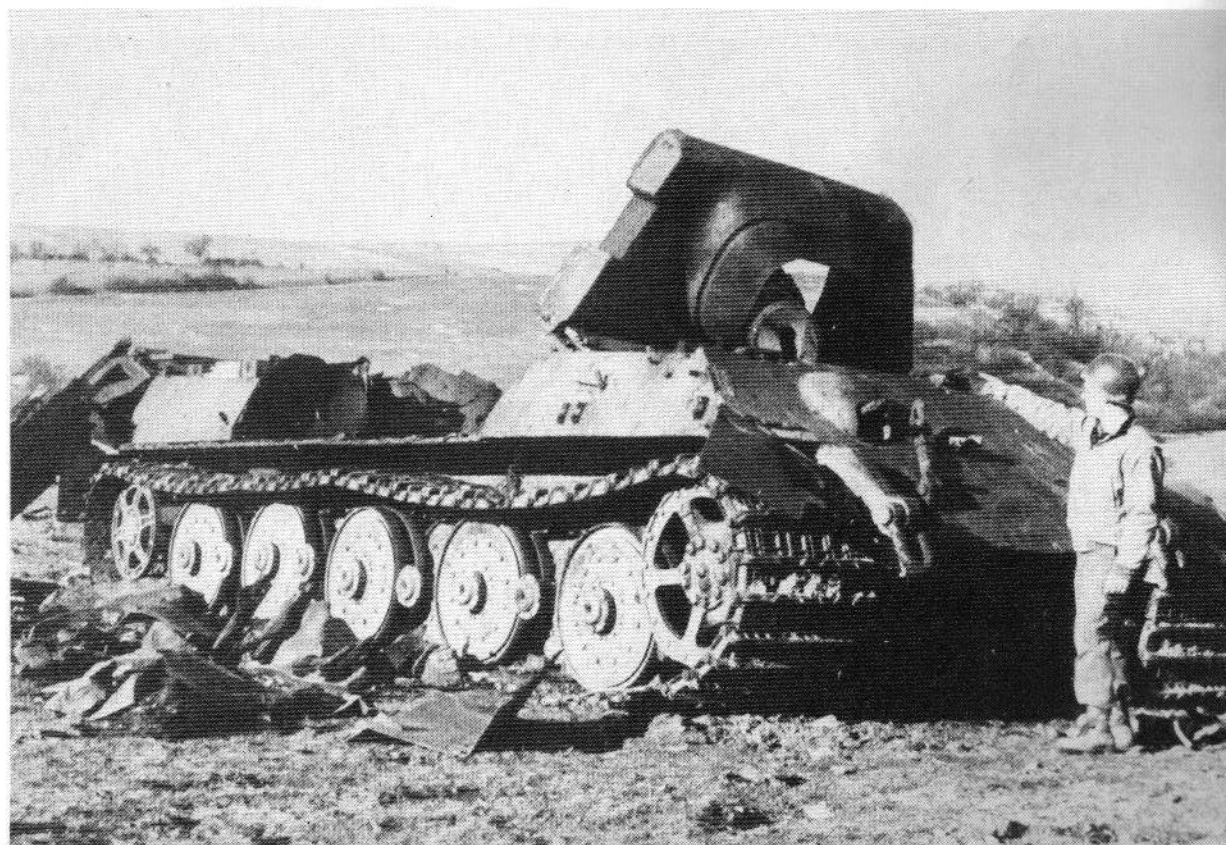



## COMBAT HISTORY

The Jagdtiger was used in combat essentially by two heavy Jagdpanzer units, 512 and 653.

Heavy Panzerjäger Unit 512 was formed in Paderborn on February 11, 1945 (partially from what remained of Panzerjäger Unit 424) and commanded by Hauptmann Scherf. On March 10 the 1st Company (Oberleutnant Ernst) saw action at the Remagen bridgehead. At that time the company had only about half of its complement (six Jagdtigers) and retreated to the Siegen area. Then it moved through the Lüdenschied-Hagen area to the Ergste region and received orders to move along R 233 and relieve Unna.

The 2nd Company (Oberleutnant Carius), which was meanwhile transported by rail to the Siegburg area, saw some action with the LIII. Panzer Corps. After losing two vehicles, it retreated along the Sieg, where two more of its Jagdtiger were lost to air attacks. Two more were lost in combat around Siegen and Weidenau, though not to enemy fire. On April 11, 1945 the unit's first and only concerted action took place during the defense of Unna. The Ruhr pocket was meanwhile closed, and a focal-point deployment of these armored defense weapons with their high firepower never took place.



Above: The Jagdtigers were picked up directly from the factory by commands from the troops. This photo shows a vehicle of Panzerjäger Unit 512 passing through St. Valentin.

Left: At a facility outside St. Valentin the Jagdtigers were armed and prepared for rail transport to Paderborn. The lighthearted name of "Sunny Boy" was chalked on by the crew.

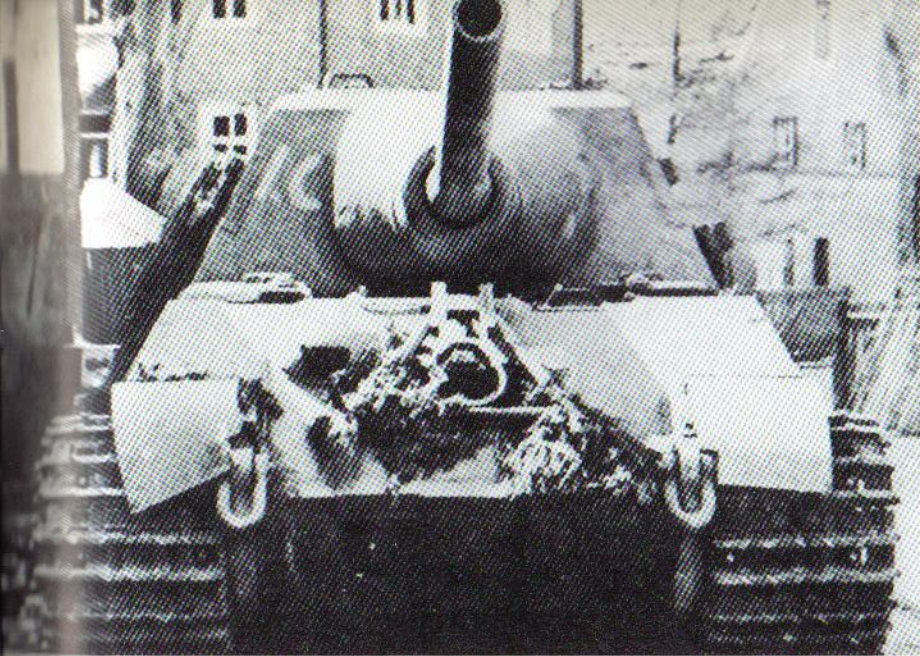

An abandoned Jagdtiger of the 2nd Company of Panzerjäger Unit 512 in Obernetphen, near Siegen. The "I. C" (1st Class designation indicates that the Americans regarded this tank as booty of first-class significance.

A good look at a Jagdtiger that ran short of fuel. The vehicle took a whole series of hits, some of them serious; on the bowplate two glancing hits can be seen, and one took a piece out of the gun mount. After being refueled, it was taken by US soldiers to a collection point for captured materials, and is now in the tank museum at Aberdeen.



Above: Two abandoned Jagdtigers of the 1st Company of Panzerjäger Unit 512 at Neustadt on the Wied. The tank in the foreground obviously had problems with its cooling system and could not be made mobile. Neither vehicle was blown up by its crew.

The rear end of this tank shows what put it out of commission. While towing another vehicle, it suffered damage and was left with a towline still attached at the left rear.

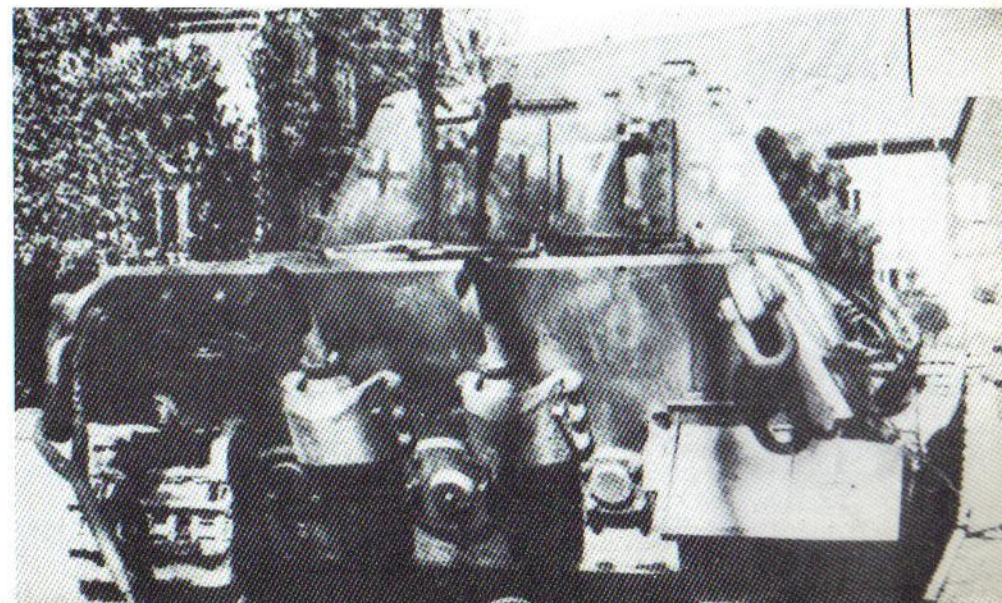
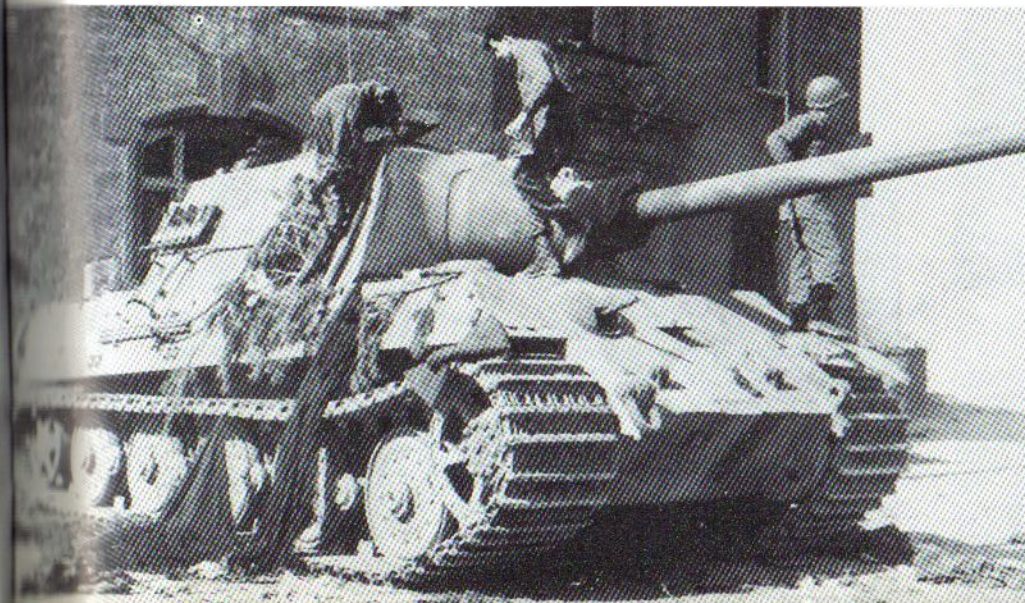



This series of pictures shows the last three Jagdtigers of the 1st Company of Panzerjäger Unit 512 on their last trip to the city hall square in Iserlohn, in the Ruhr pocket. The remaining men of the company laid down their arms, gave up their personal equipment and stood before their tanks one last time. The company surrendered by report of Company Commander Oberleutnant Ernst to an American staff officer.



On April 15 the 2nd Company (still with 7 Jagdtigers) was disbanded in Letmathe near Iserlohn. The 1st Company was in combat action considerably more often and destroyed 16 enemy tanks south of Unna before it surrendered in Iserlohn.

Nine of the unit's Jagdtigers remained in Austria along with the command that had gone to get them, and were put to use by the 6th SS Panzer Army. On the afternoon of May 9, 1945 (!) they destroyed several Soviet KW 85's before the last two of them were abandoned and their crews fought their way to the American troops.

The Heavy Panzerjäger Unit 653 (last Commander, Major Fromme) and its nine Jagdtigers took part in Operation Northwind in the west in December of 1944 with the 5th Panzer Army.

After that the unit was refreshed and saw action sporadically against American troops in the Schweningen-Chiemsee area of southern Germany. The last Jagdtigers were blown up near the Austrian border.

A few Jagdtigers were used in the Harz Mountains just before the war ended.

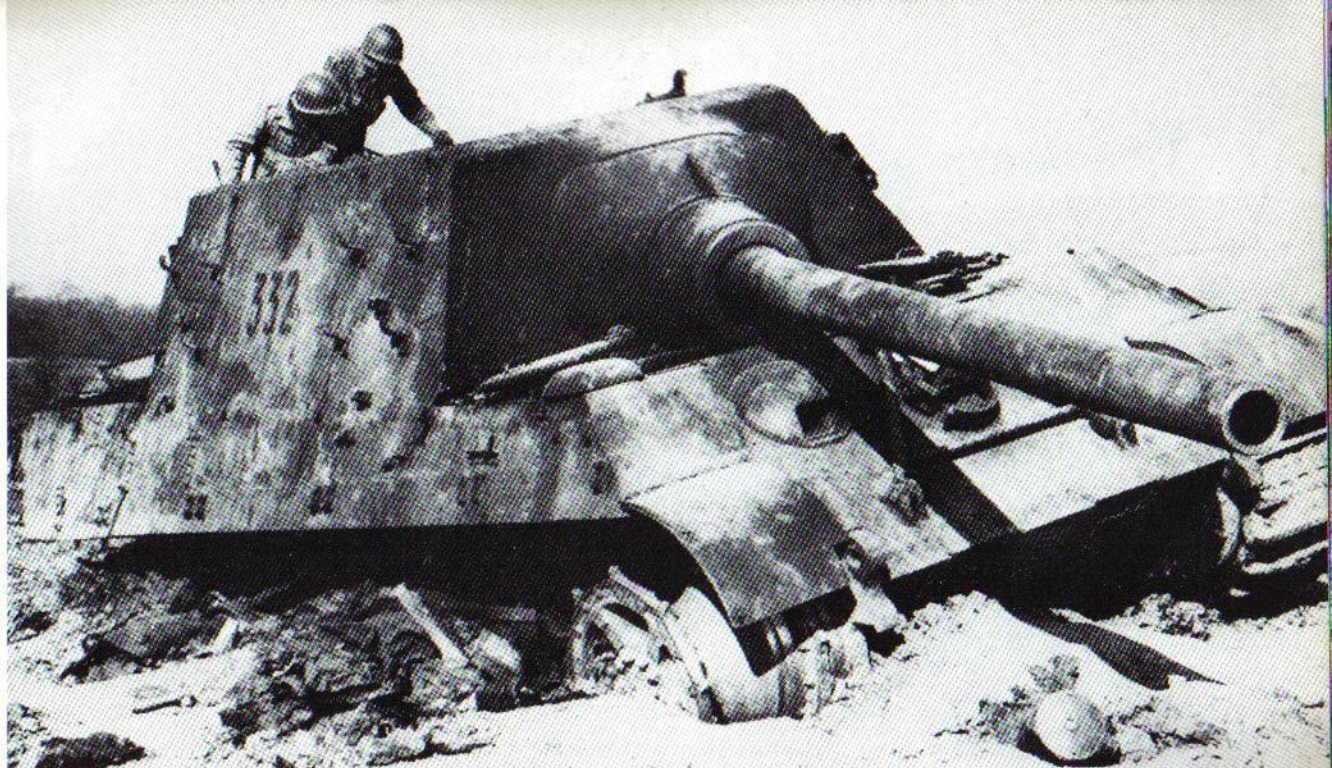

Above: Several Jagdtigers were still used individually in the Harz. This one was destroyed by fighter-bombers near St. Andreasberg on April 16, 1945.

By far the greatest number of Jagdtigers were lost through technical defects or lack of fuel. The crews blew them up with one charge each in the fighting and engine compartments. The explosion of the ammunition which was detonated in the process tore the heavy sidewalls off, threw off the roof and pushed the gun out the front.



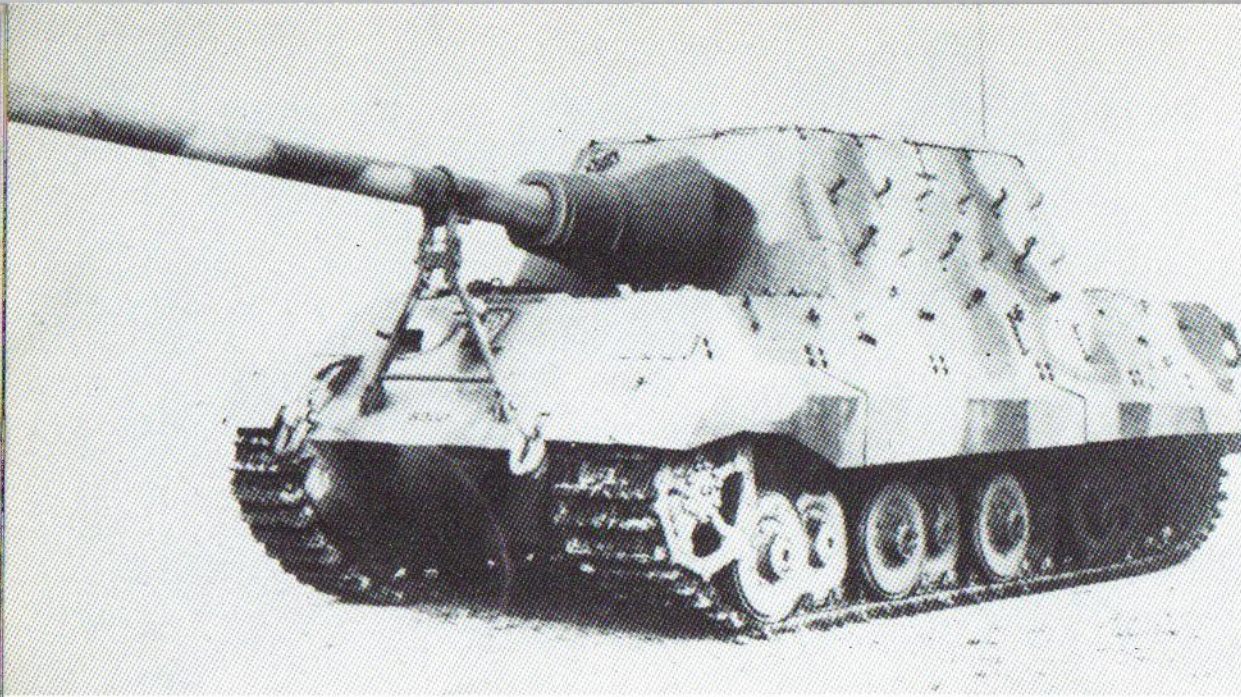

Above: Ten hulls were fitted with Porsche running gear, each with four pairs of torsion-bar wheels on each side.

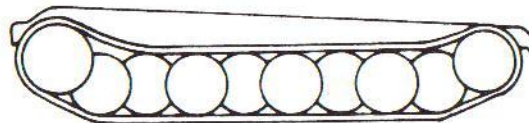
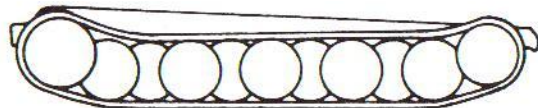
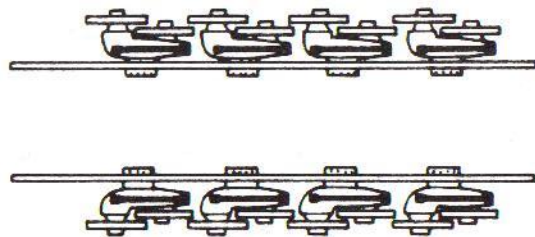
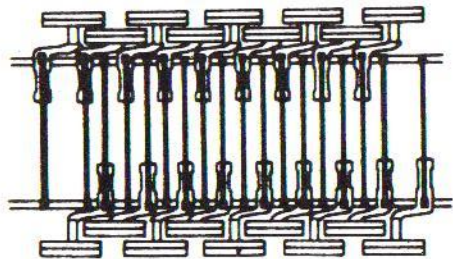
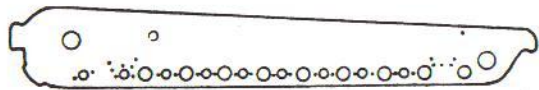
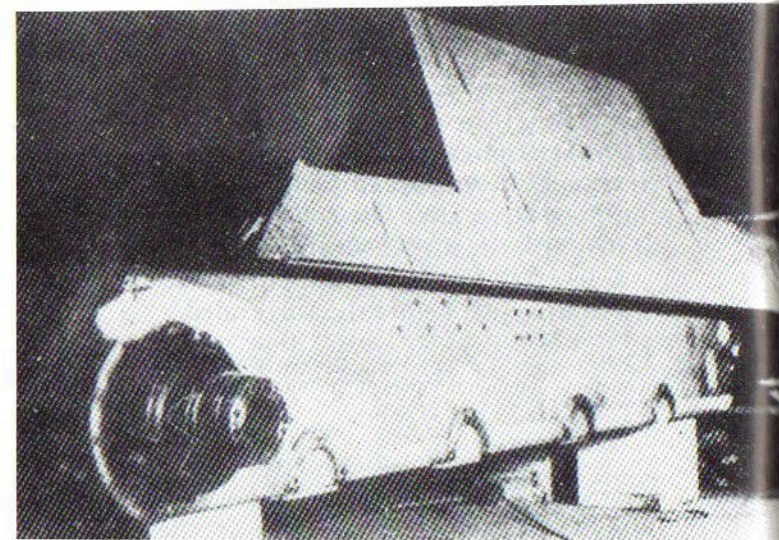
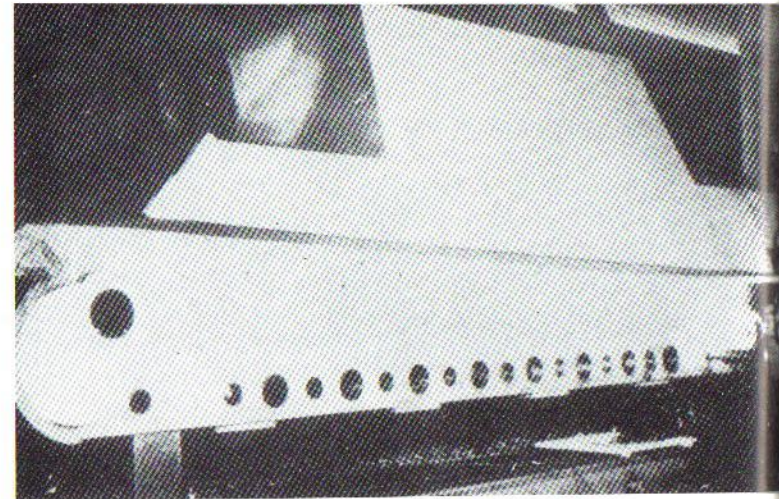

These two pictures show the principal difference between the two running gear types. Installing the Porsche running gear took considerably less time to prepare the hull.





Left: These two pictures show a Porsche Jagdtiger on a test drive in the Senne.

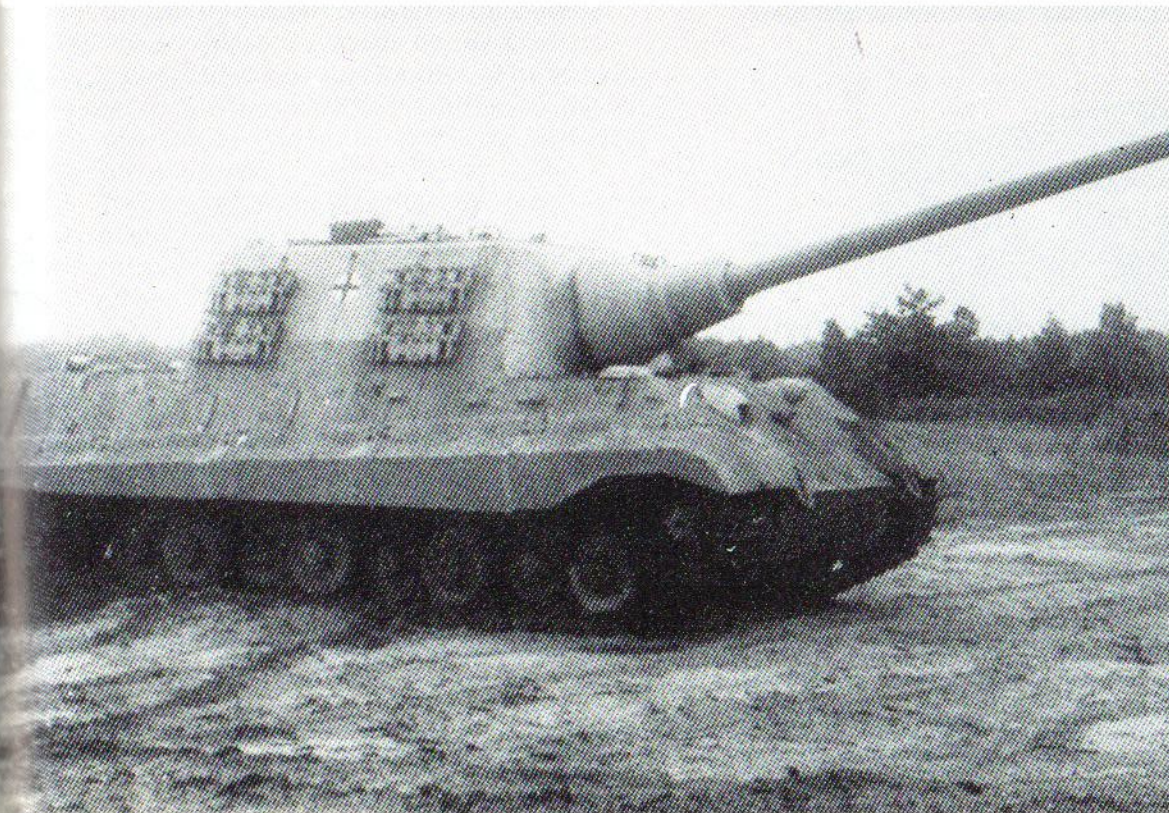
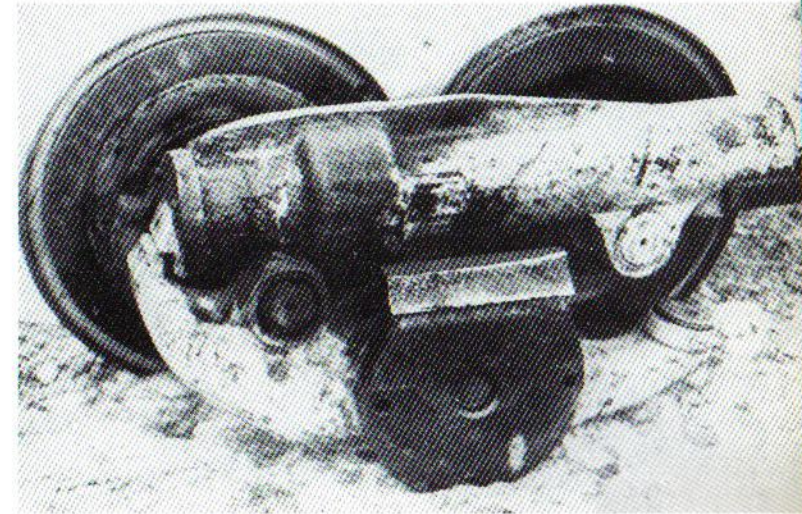

During these tests, the attaching flange of the third pair of wheels broke on the left side. In the cylinder above the break is the torsion bar to whose housing (right) one road wheel is attached. Under it is the primary arm with the other road wheel, which acts against the torsion bar. The drawings below show the two-wheel "Rollwagen" unit from the front and the back.

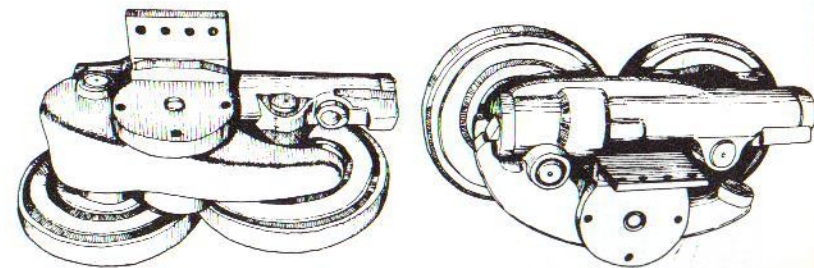

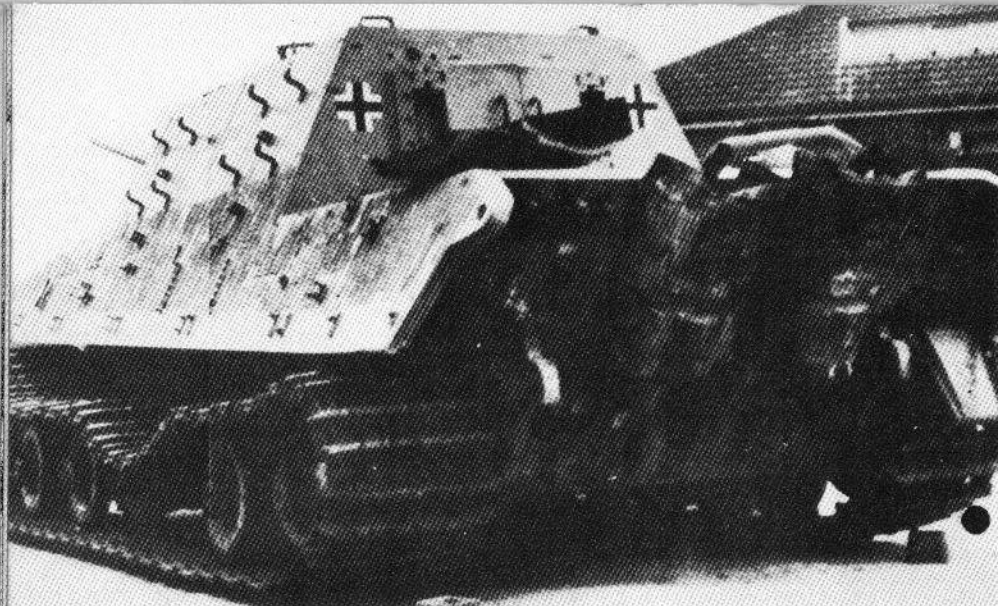

Above: Rear view of a Jagdtiger fitted with Porsche running gear; damage to the running gear has put it out of commission. Numerous machine-gun bullets can be seen to have hit the rear.

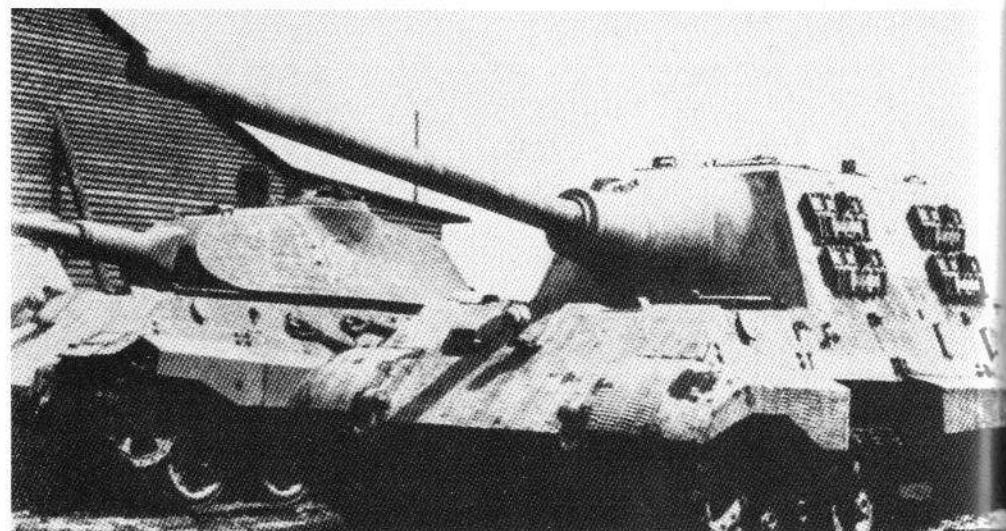

Above: This photo shows a Porsche Jagdtiger beside a Tiger II tank with a Porsche turret. In comparing these two giants, one cannot help but notice the very high superstructure of the Jagdtiger.

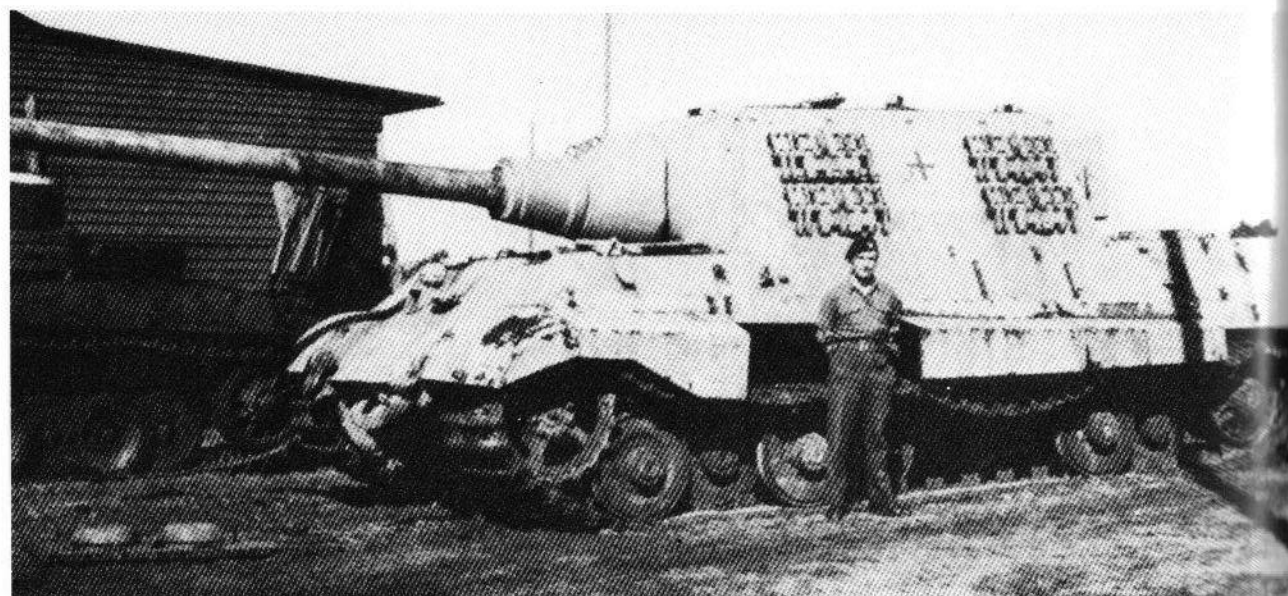

Right: This Porsche Jagdtiger broke down during driving tests and fell into British hands at Sennelager. To its right, partially visible, is a VK 3001 (H).

## 38cm "Tiger" Assault Mortar

### DEVELOPMENT

After numerous projects to make heavy high-angle guns mobile by mounting them on tank chassis had already failed, it was suggested to Hitler on August 5, 1943 that an assault mortar should be introduced, using the 38cm RTg (Raketen-Tauchgranate) launcher already developed for the navy by Rheinmetall-Borsig.

This weapon was intended for land-based submarine fighting and was to be used at suitable coastal installations; its range was to be about 3000 meters.

In order to stand the recoil of up to 40 tons, an appropriate chassis was needed, and the only available one was the Tiger I. On Guderian's suggestion, only one prototype was originally built by ALKETT in Spandau. The armor plate was made by the Brandenburg Iron Works of Kirchmöser. The naval launcher was meanwhile modified to meet army needs by Rheinmetall-Borsig at their Sömmerda works.

The first prototype was shown to Hitler on October 20, 1943 at the Arys training camp in East Prussia.

Difficulties appeared at first in view of the availability of a sufficient number of chassis, since production of the Tiger I tank was well below the numbers that had been planned for. Even early in May 1944 the 38cm assault mortar was still in danger of being cancelled once and for all. Finally Hitler ordered that its production was not to cut into ongoing new production, and that for the preparation of twelve (also called "Sturmtiger") units for the time being, only hulls be used that had been shipped back from the front for rebuilding.



Front and side views of one of the first production vehicles during firing to establish tables of shot values. The word "Geheim" (secret) was stamped on the photo.

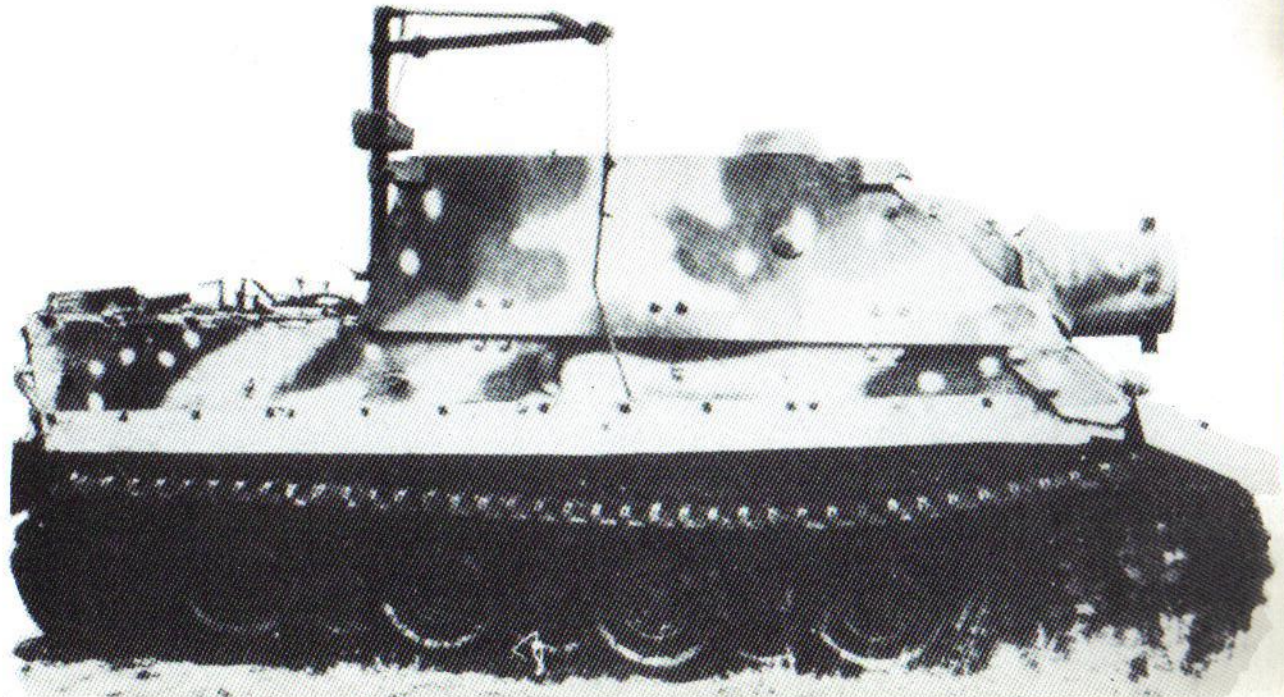

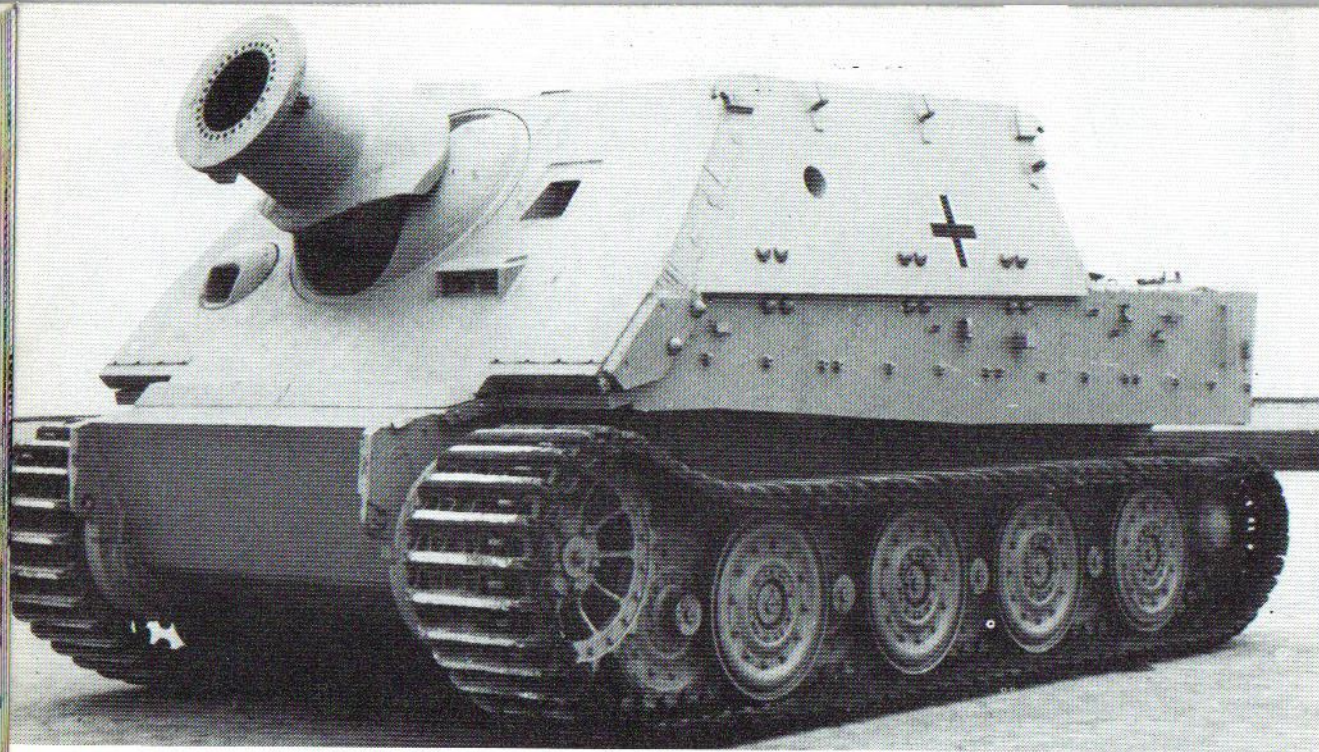

Two side views of the Jagdtiger that is at the Military Technology Study Collection in Koblenz today. The steel ring on the mouth of the launcher was added later as a counterweight to the base in the vehicle, in order to make elevation aiming easier.

After thirteen Sturmtigers had been finished by the end of September 1944, Hitler commanded on September 23, 1944 that five more of them were to be finished. This was done by the end of December. On January 5, 1945 Hitler declared that more armored mortars were to be built, but this did not happen, on account of production difficulties.

#### REBUILDING

The chassis delivered for rebuilding were all equipped — unlike the prototype — with rubber-sprung steel road wheels, in order to carry the weight of the vehicle, more than eight tons, more easily.

The fighting compartment was formed of a fixed box-like superstructure with armor plate 150mm thick in front and 80mm on the sides; the roof armor measured 40 to 25mm.

Despite the large superstructure, there was only limited storage space for the one-piece 38cm shells, which were 1.49 meters long. Only six each (two vertical sets of three) could be carried on the interior side walls.

To make it possible to remove the shells, which weighed 330 kp, from their racks, a trolley was mounted on rails on the ceiling. A loading tray with rollers served in loading the shells. In the barrel and on its ammunition advance one more shell each could be carried, so that a maximum of 14 shells were on hand. A swiveling loading crane, mounted outside at the right rear, was used to load shells aboard.

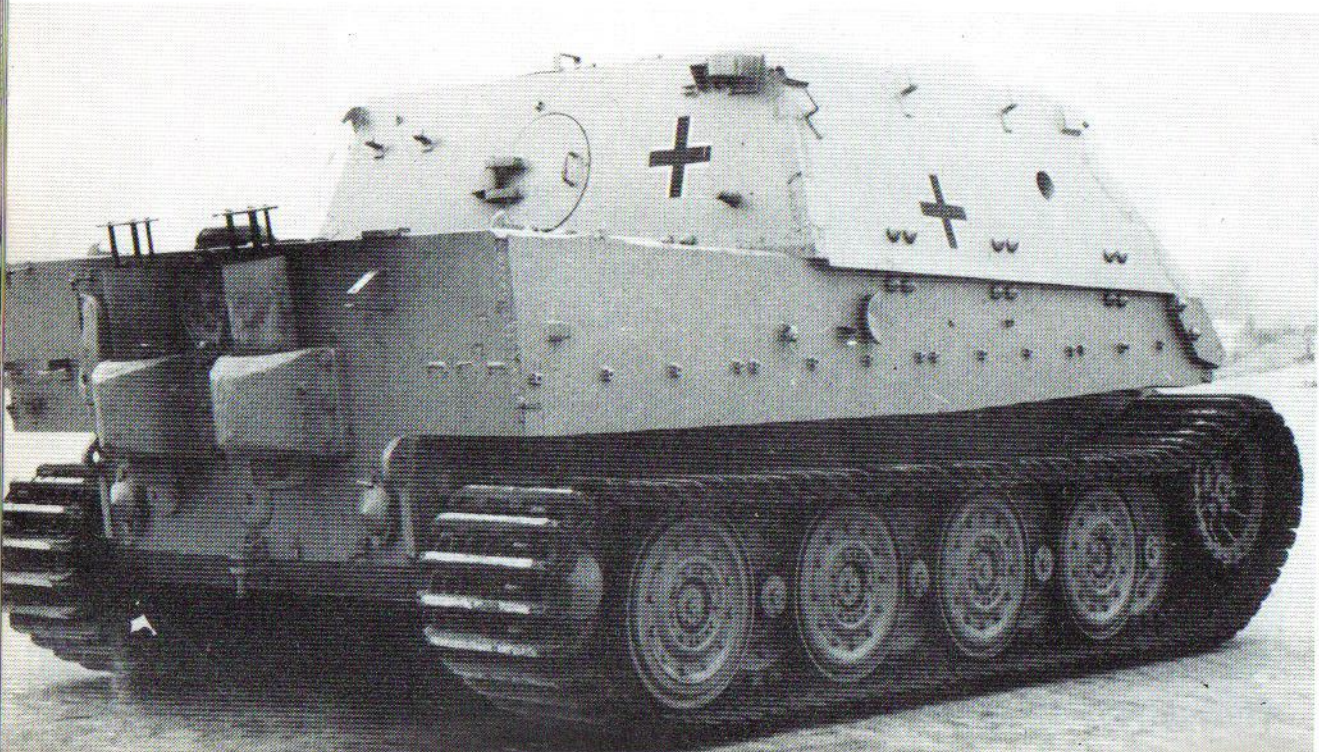

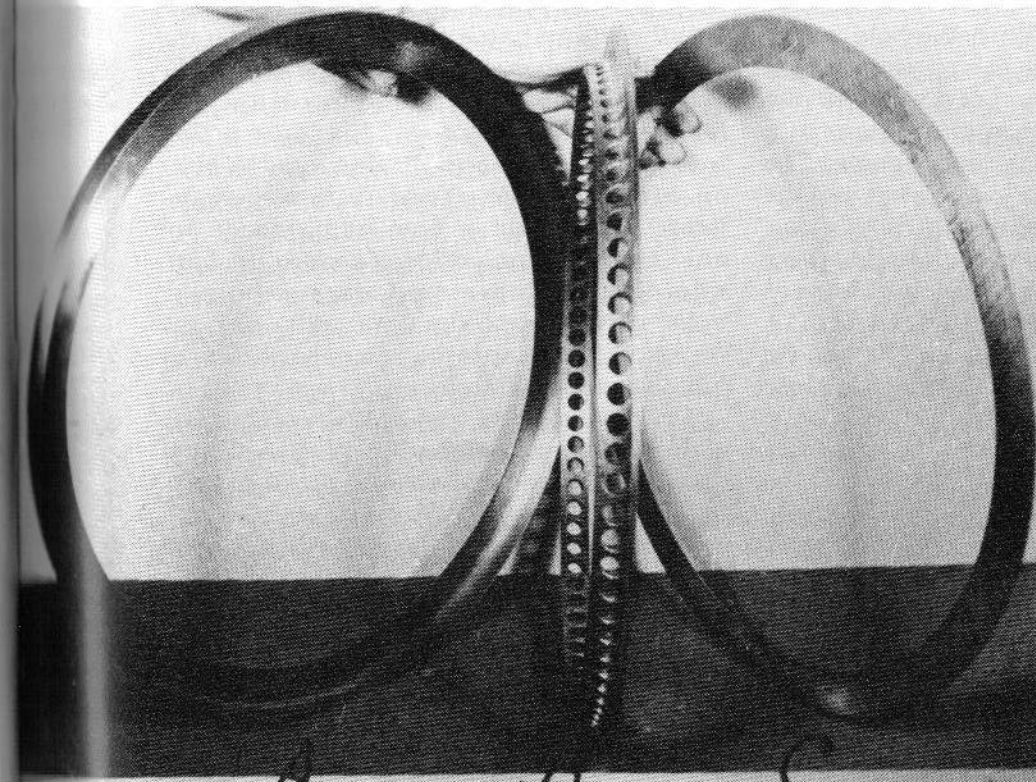
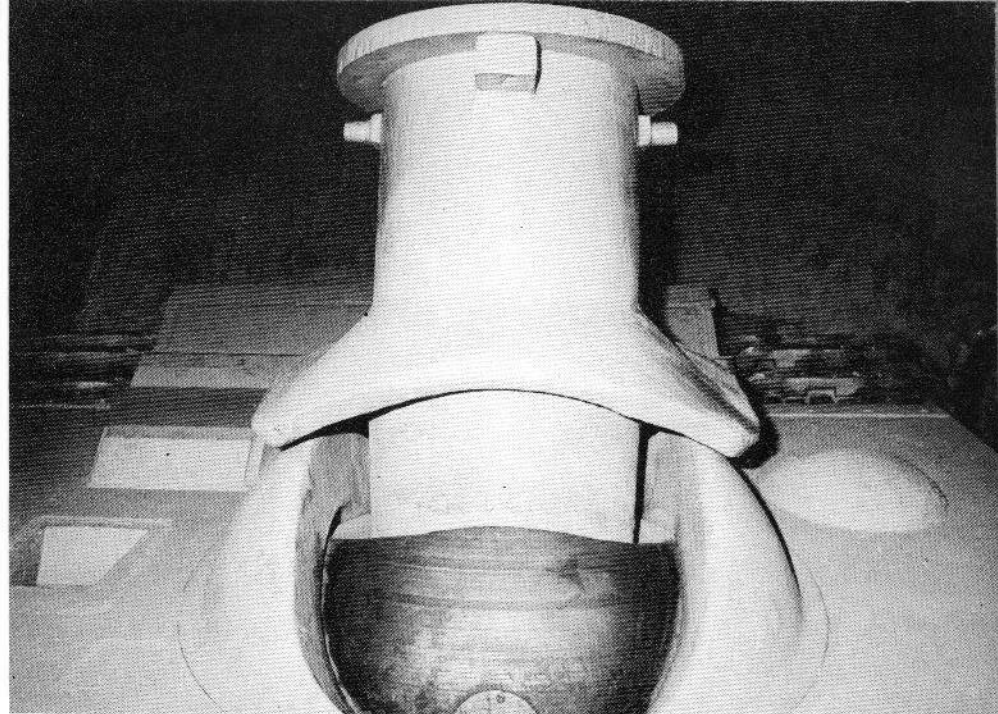
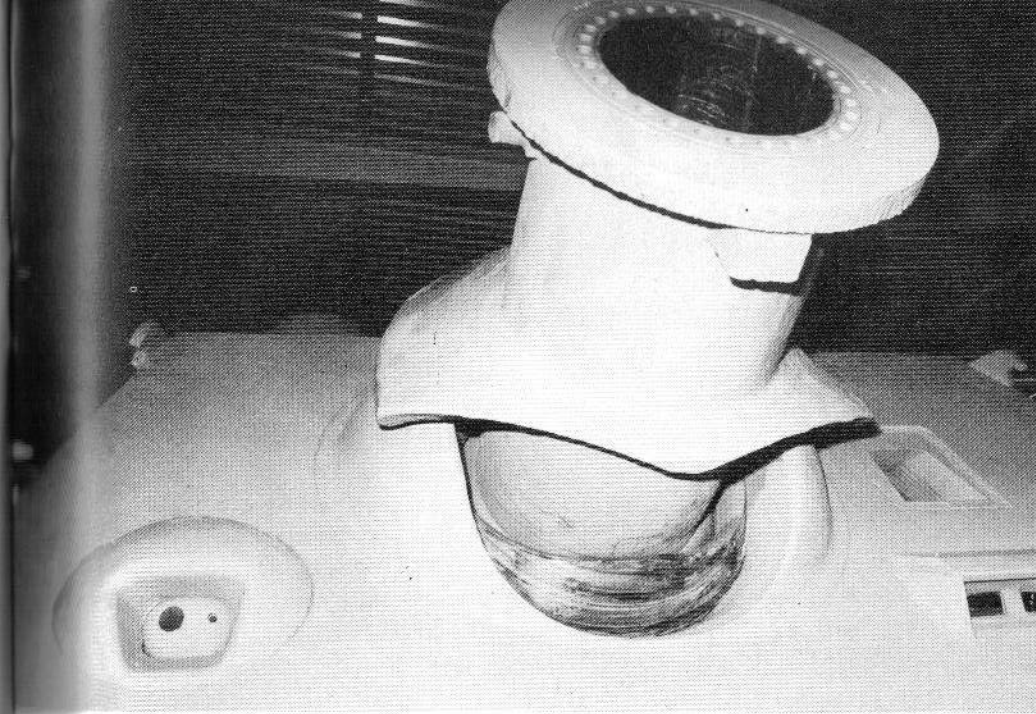

Above:  
Two views of the launcher barrel. The ring of gas pressure openings and the barrel sheath with shield, made of a single cast piece, are clear to see. At the left front are the two visors for the driver and, over them, the indented opening for the aiming telescope. At right is the round mantelet for the bow machine gun. The gun was pointed through the smaller of the two openings.

Left:  
A close-up view of the rear internal barrel mount segment with the rear gas-pressure openings.

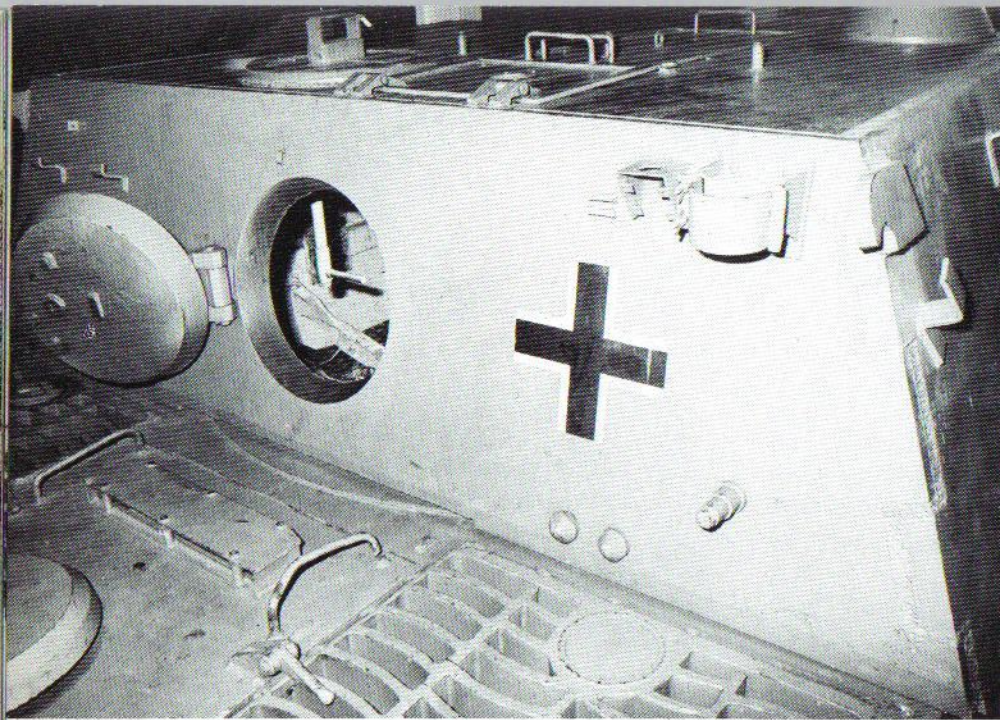

Above:  
Rear view of the superstructure. The mount of the (missing) loading crane can be seen, as well as the round exit hatch.

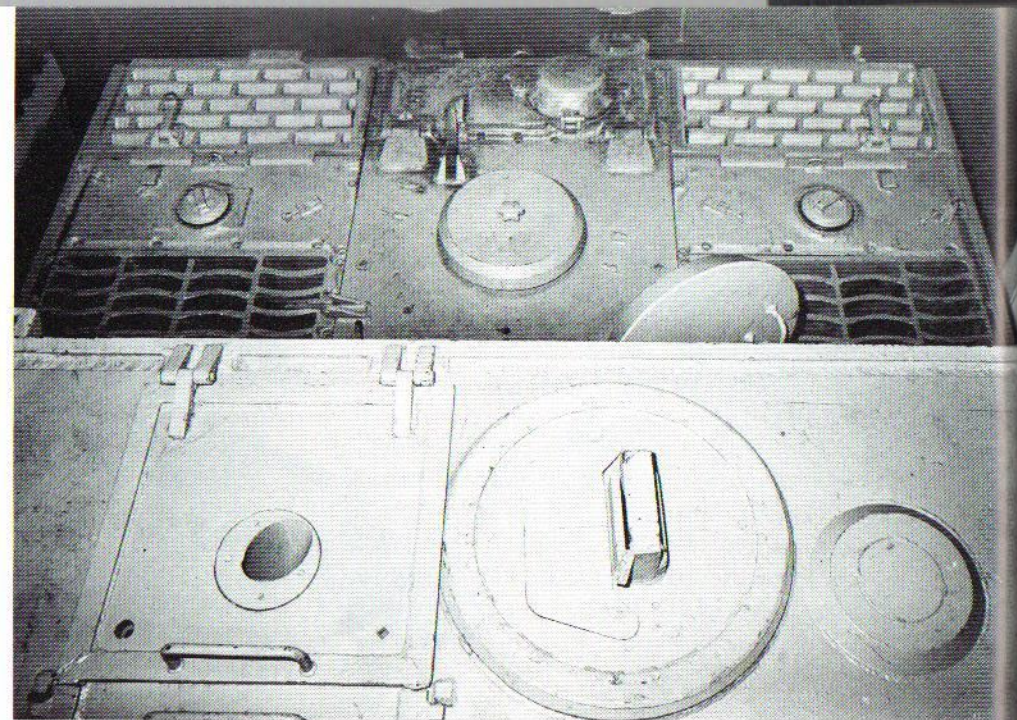

Upper right:  
The tail as seen from the roof of the turret. In the foreground the backward-folding cover of the small loading hatch can be seen, along with the opening for the smokelaying system. Next to it is a swinging periscope. The stereotelescope was extended out through the hatch; with its help ranges were measured.

First the small loading hatch in the roof was opened rearward. With the help of the crane, the large loading bay cover was then removed. The shells were set down near the right side of the vehicle and lifted one at a time, using a lifting sling on the crane. The crane was swung over the loading bay and the shell lowered to the loading tray.

Other than the two loading hatches, there was a ventilator opening at the right front of the roof, and a hatch at the right rear. A launcher was located in the small loading hatch and operated from inside for close combat.

In the forward area of each side wall there was a close combat hatch that could be opened from inside. An exit hatch whose cover swung outward was located at the rear.

The front plate, set at a 45-degree angle, had the primary weapon mounted in the

middle of a round shield. To the right of it was the round hatch for the MG 34. To the left of the 38cm mortar were two visors for the driver, and above them the indented opening for the aiming telescope. This construction was screwed to the hull inside, closed by bolts on each side. these (two each upper and lower) bolts could be seen from outside but only opened from inside. Forward on both sides of the bow there were also two holding bolts. After these bolts were taken out, the superstructure could be removed, lifted by four eyes attached to its top.

The running gear and hull were like those of the final version of the Tiger I, Type E, and do not need to be described in detail here.

The mobility of the Sturmtyger was much worse than that of the Tiger I tank on account of its weight.

## 38cm Rocket Launcher RW 61

The rocket launcher that was rebuilt for army use fired either an explosive shell (4581) or a hollow-charge shell (4592) with a range of up to 5700 meters. Nothing is known of the use of the hollow-charge shell, intended for use against reinforced concrete fortifications, during the war, thus it can be assumed that only the explosive shell was actually used.

The explosive charge walong and consisted of two parts, a seamless, longitudinally welded cartridge (500mm long) and the ballistic cap. It was linked to the combustion chamber (470mm long) by an unthreaded tension ring. The weight of the explosive (TNT) was 135 kp. The mechanically functioning igniter was screwed onto the front of the shell.

The combustion chamber was filled with some 40 kp of diglycol powder in rod form. This load was ignited from the front with the help of coarse-grained black powder. The igniter was attached to the underside of the shell. After the shell was set on the opened ammunition loading tray (with the breech opened), the procedure that pushed it into its firing position in the launcher was halted. First the launcher had to be lowered to its loading position (zero degrees).

With the help of the loading apparatus, lengthened to form two handles, the crew (four soldiers, not counting the driver) pushed the shell into the barrel until the foremost guiding ring reached the rifling (nine riflings), which had been extended backward for better engagement. Then a sprung bolt snapped into place and prevented the shell from sliding backward.

Now the igniter was placed in a socket in the breech-lock. The use of a hand crank low on the breech activated a pinion that engaged

a gear which closed the horizontal breech to the left.

After that, the rocket launcher was aimed. The elevation crank was located at the left near the base, and the arc of elevation extended from zero to 85 degrees. The entire vehicle was first turned for traverse aiming; then fine aiming was done by using the traverse aiming crank, which was located over the barrel opening. The traverse aiming arc was +/-10 degrees. If necessary, the commander could determine the range by using an optical stereoscopic range finder, which was used externally. This laborious loading and aiming process could scarcely be performed, even by a trained crew, in less than ten minutes.

Launching took place with the help of an igniter cartridge; its burning lit the launching igniter.

The rocket left the mortar at a velocity of about 300 meters per second. The gases that left the rear of the shell via the 32 combustion-chamber jets developed a thrust of about 30 kp/cc. In order to decrease the recoil of the mortar considerably and not to make the already cramped fighting compartment even smaller as a result of the recoil, a clever solution was found. The mortar barrel consisted of an (internal) primary barrel and an external barrel sheath. The barrel and sheath were held at the same distance by holding pieces at the rear and two half-rings at the muzzle. Holes were bored in these ring segments, fifteen in the upper and sixteen in the lower half. The space between the inner and outer barrels formed an empty area which could take up the exhaust gases of the launching shell and release most of their pressure forward through the exit openings;

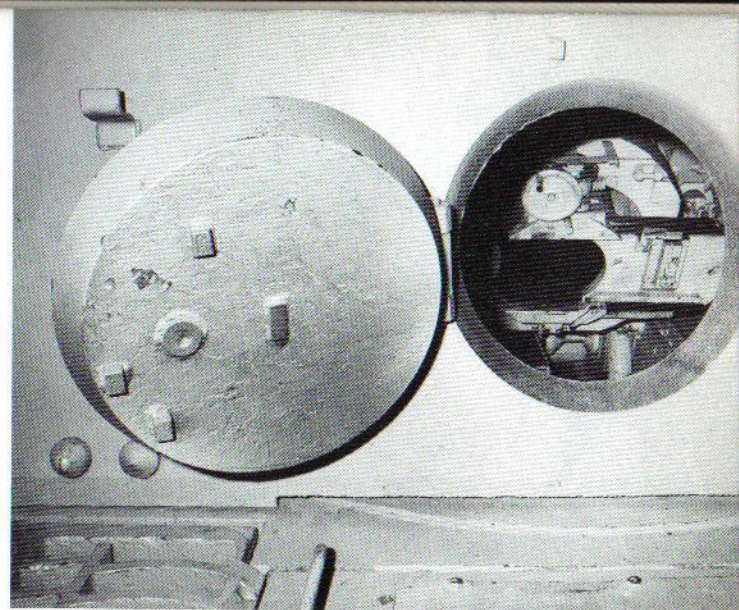

A look through the rear exit hatch into the interior and at the opened breech.

On the engine compartment cover, a segment of the circular turret turning track of the original Tiger tank can be seen.

thus only a part of the recoil energy affected the mount and the vehicle itself.

To allow the gunner to decrease the opposition to the turning of the elevation aiming gear, some vehicles had a ring-shaped counterweight welded onto the muzzle of the barrel.

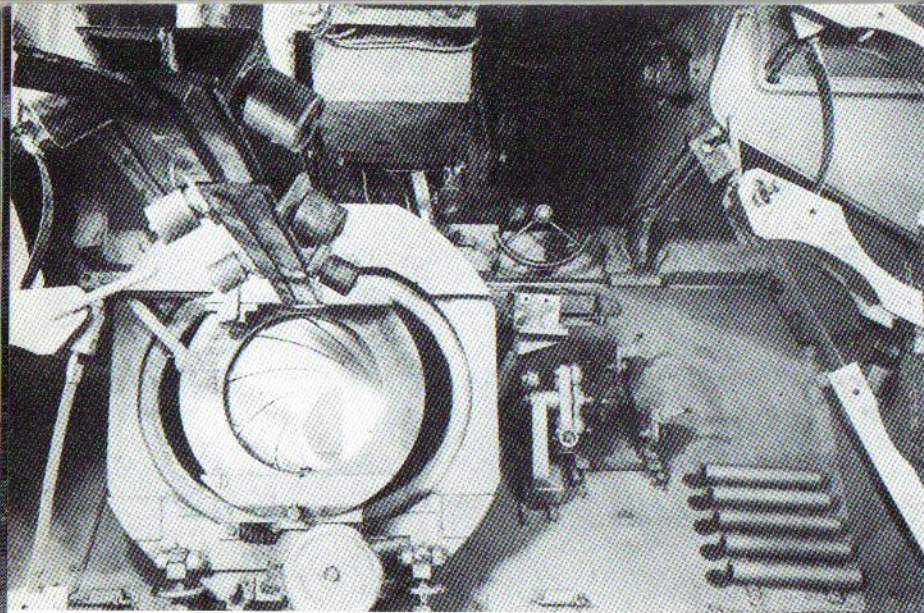

Above: Interior view of the front of the fighting compartment. The interior of the launcher barrel, with its riflings spiraling from left to right, can be seen clearly. The elevation aiming crank and the breechblock have been removed. Behind the base the six rollers of the loading tray have been attached.

The breechblock swung all the way to the left. It was activated with the help of the small crank on the geared rod at the lower right.

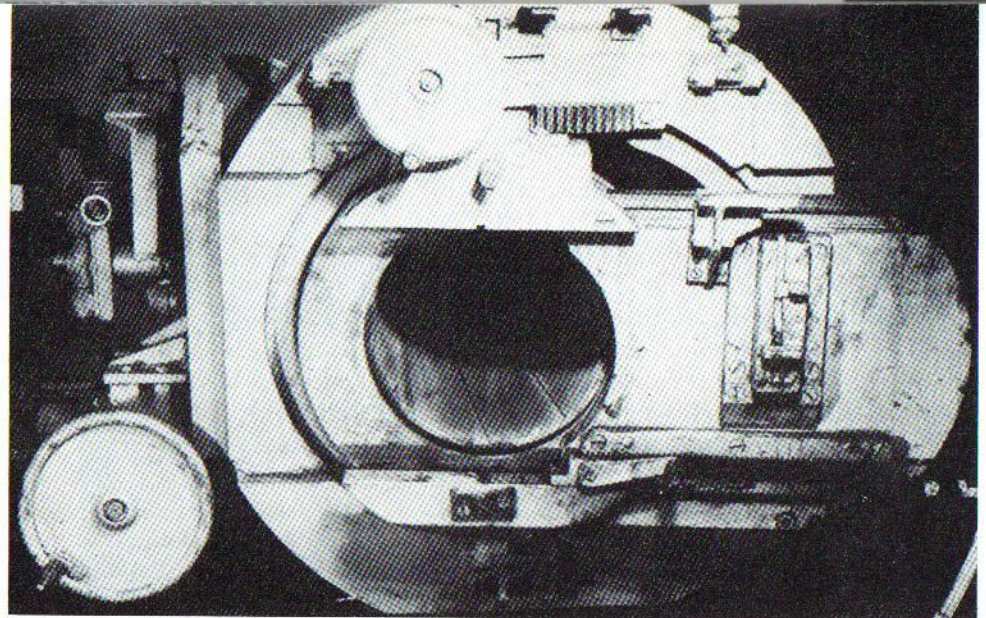

A look at the launcher's traverse aiming gear. Unlike the elevation aiming gear seen in the picture at the left, the traverse aiming wheel is spoked. The five tubes to the left, on the angled inside wall of the bow, held the smokelaying canisters; in some vehicles these were attached in a horizontal line. To the right is the visor of the aiming telescope used in aiming the launcher.

Above: Detailed view of the breech with the hand elevation aiming wheel at the lower left. The traverse aiming wheel is above, and the breechblock can be seen in its open position to the right of the barrel opening.

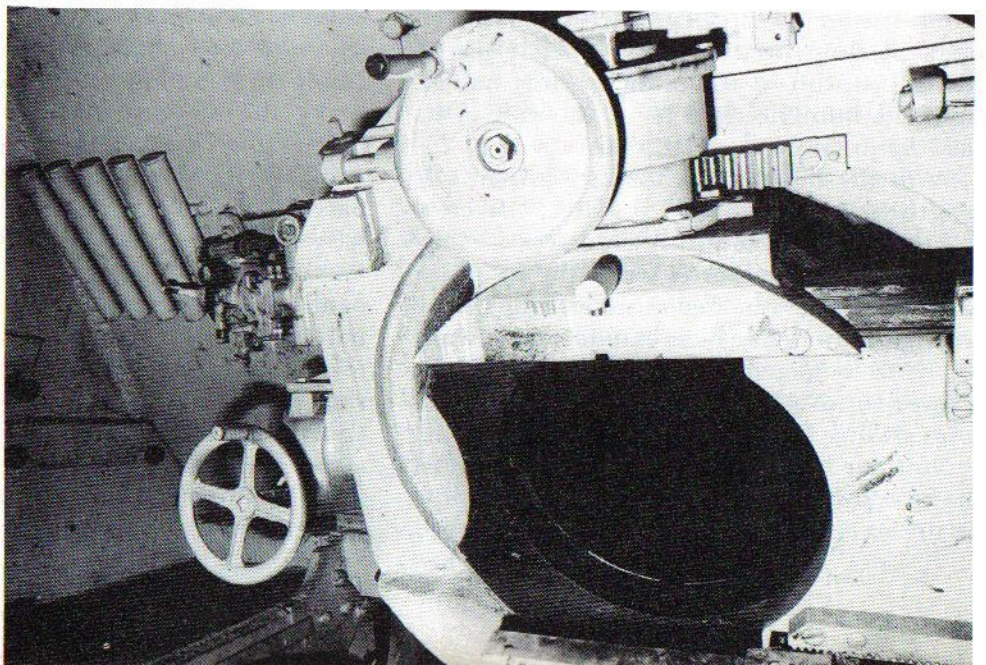
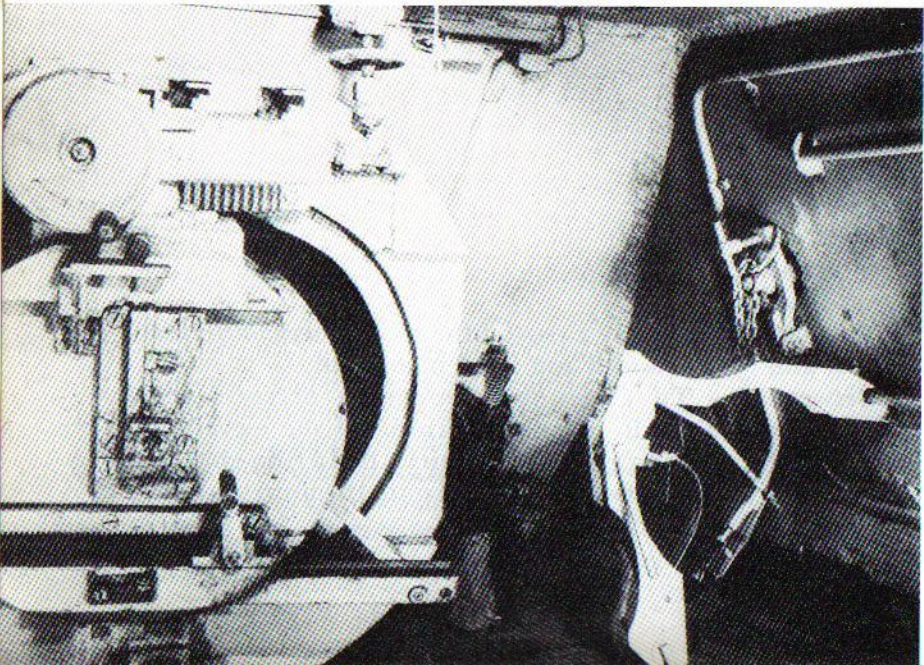



## Technical Data

### Data

Fighting weight (tons)	65
Length (mm)	6280
Width (mm)	3570
Height (mm)	2850
Horsepower	650
Fuel capacity (liters)	540
Range (on/off road)	100/60
Top speed (kph)	40
Track (mm)	2822
Road wheel size (mm)	800
Track length (mm)	3605
Track width (mm)	725
Track links	96
Ground clearance (mm)	470
Ground pressure (kp/cc)	1.5
Crew	5
Climbing (degrees)	35
Climbing (mm)	790
Spanning (mm)	2300
Armament	38cm
	StuM 61
Caliber length	L5.4
Rounds carried	14
Machine gun	1 MG 34
Rounds carried	600

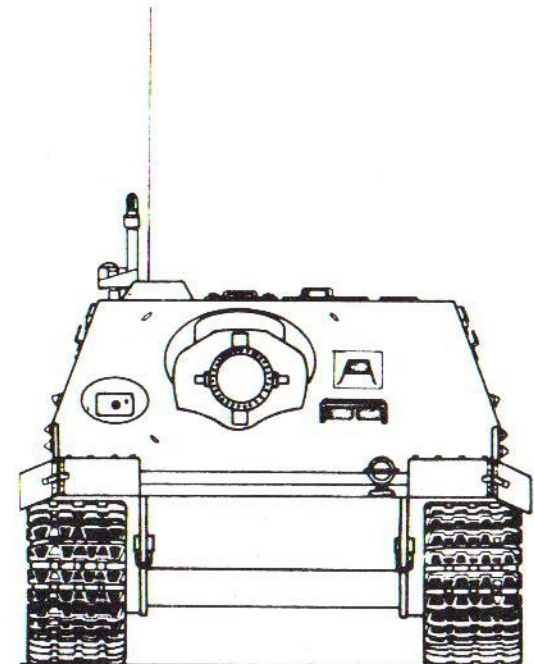
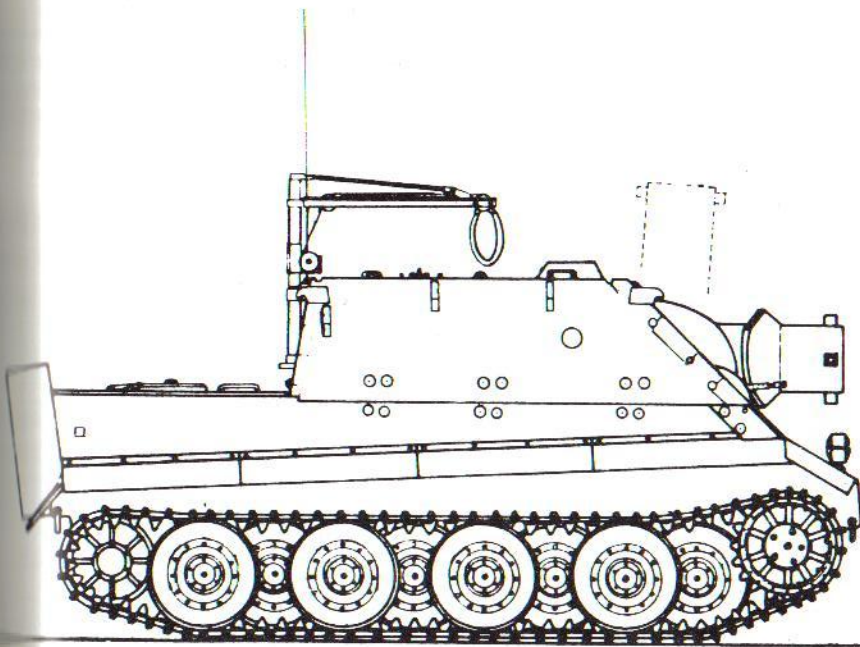
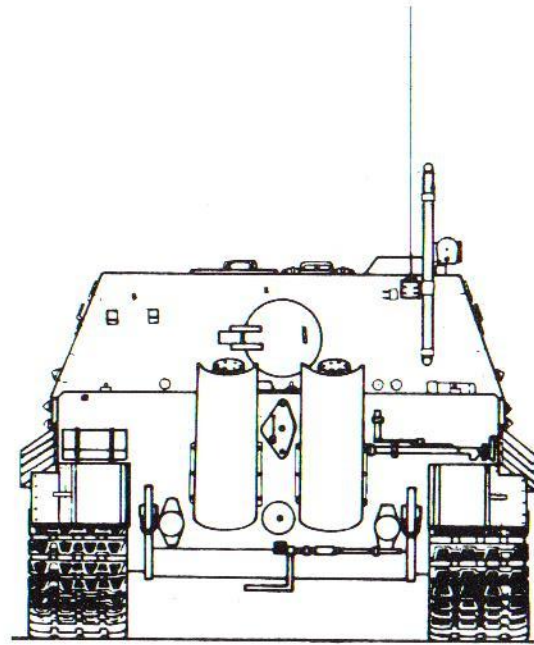
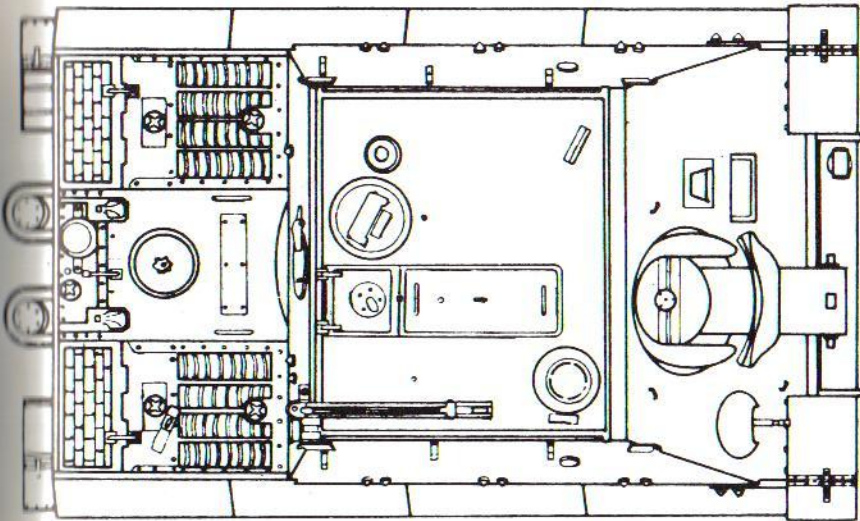

Left: four-way drawings of the Sturmtiger.



Loading ammunition into the Sturmtiger. The rocket is put down to the right of the launcher. After the packing material is removed, the sling of the loading crane is attached. The projectile is raised by using the hand crank of the crane and lowered into the interior through the opened ammunition loading hatch.

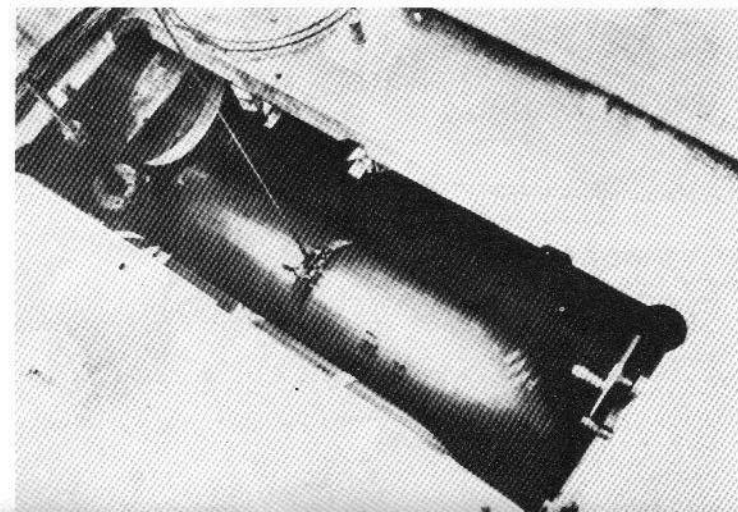
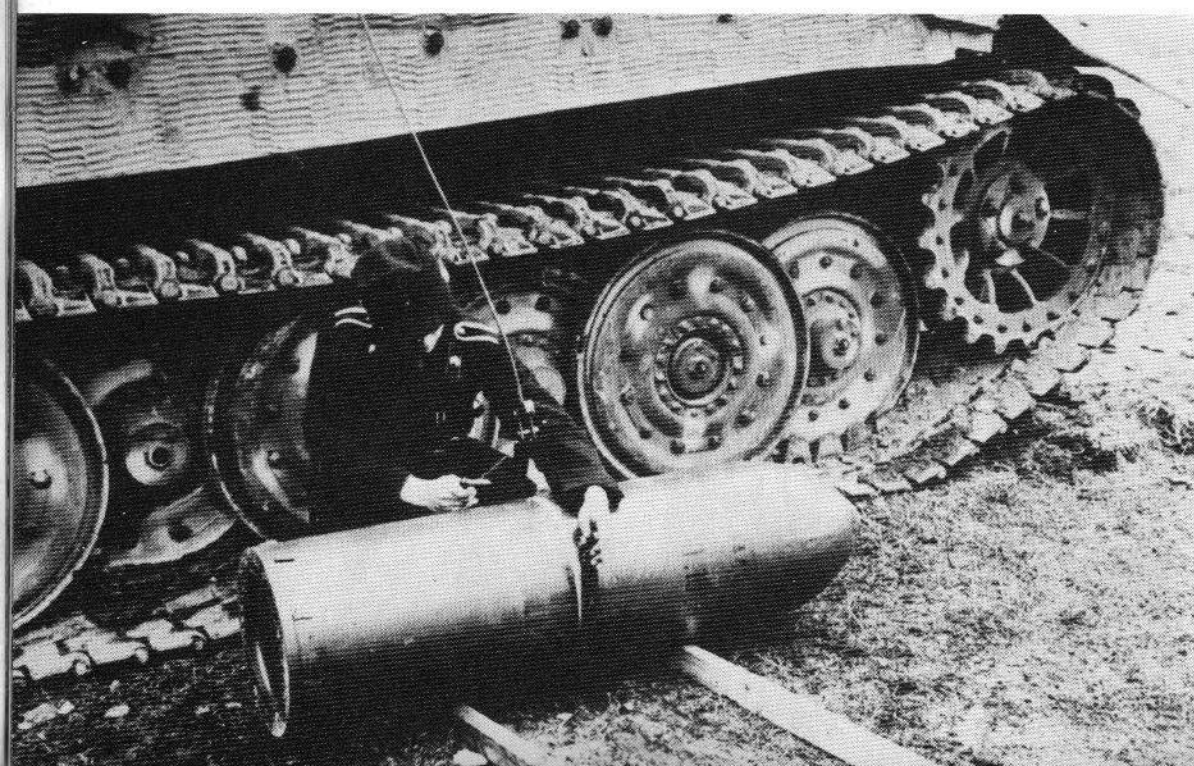

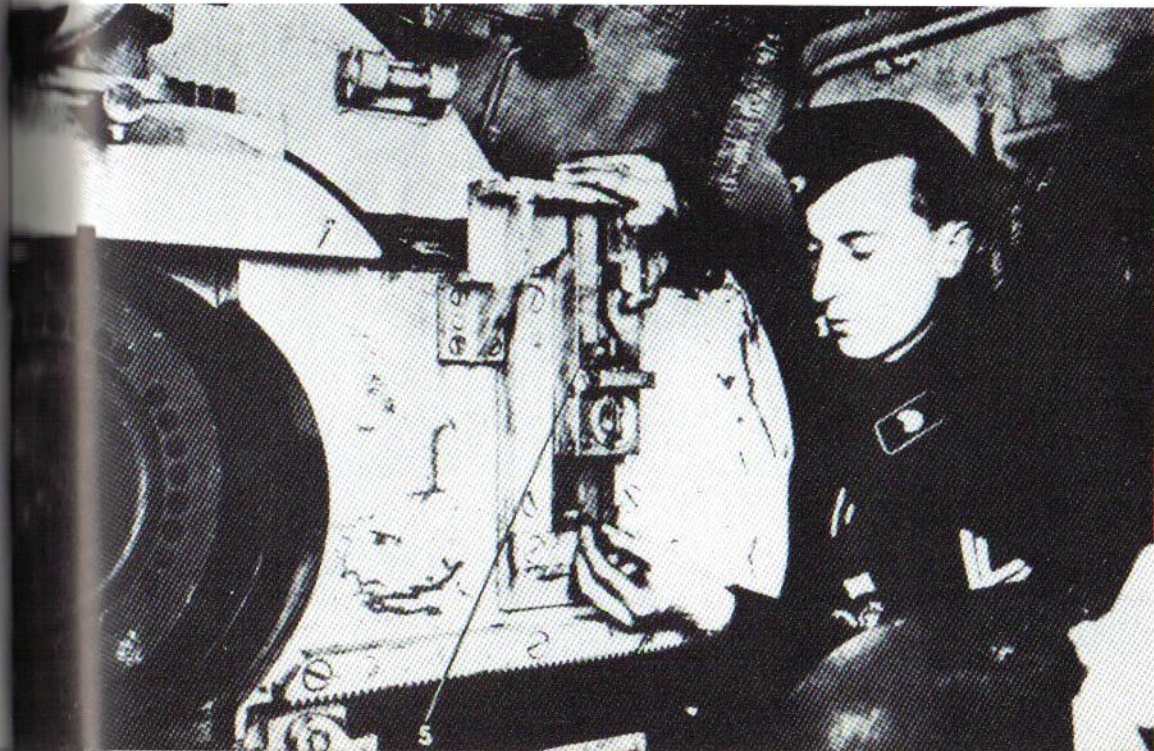
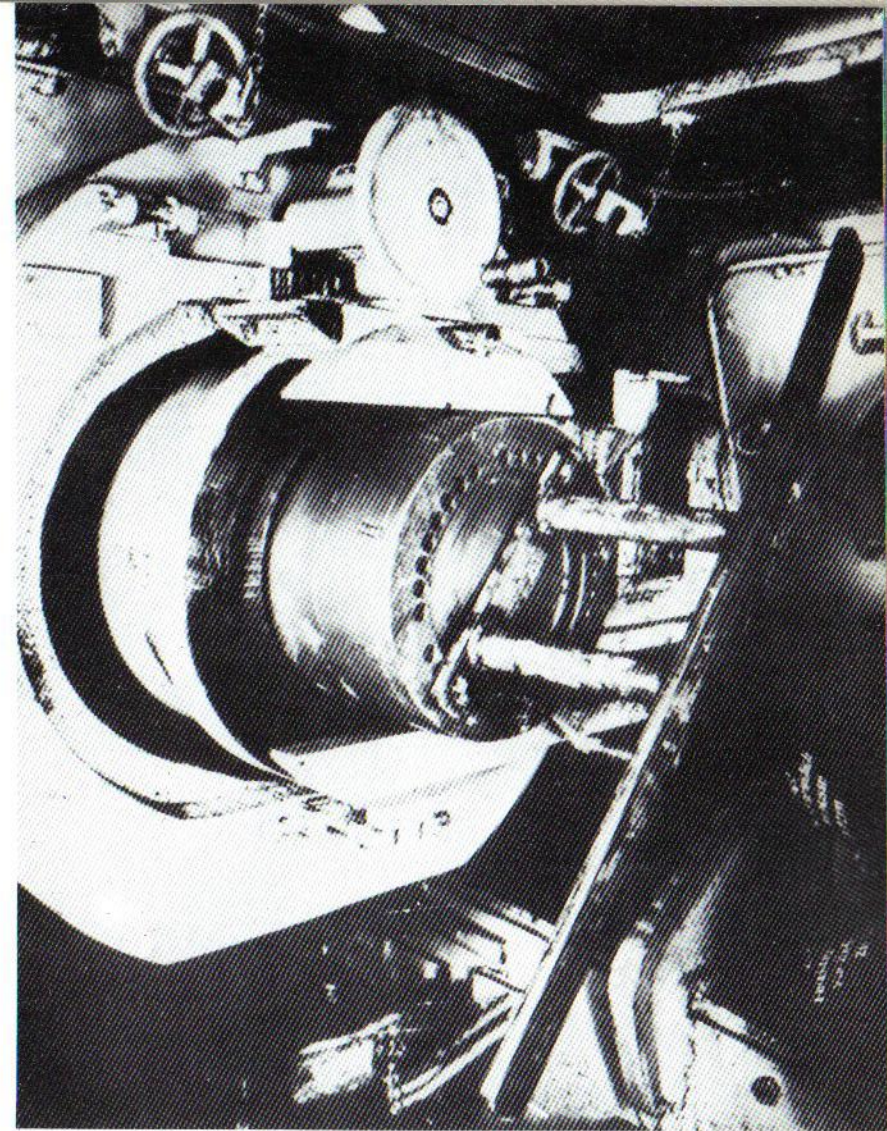
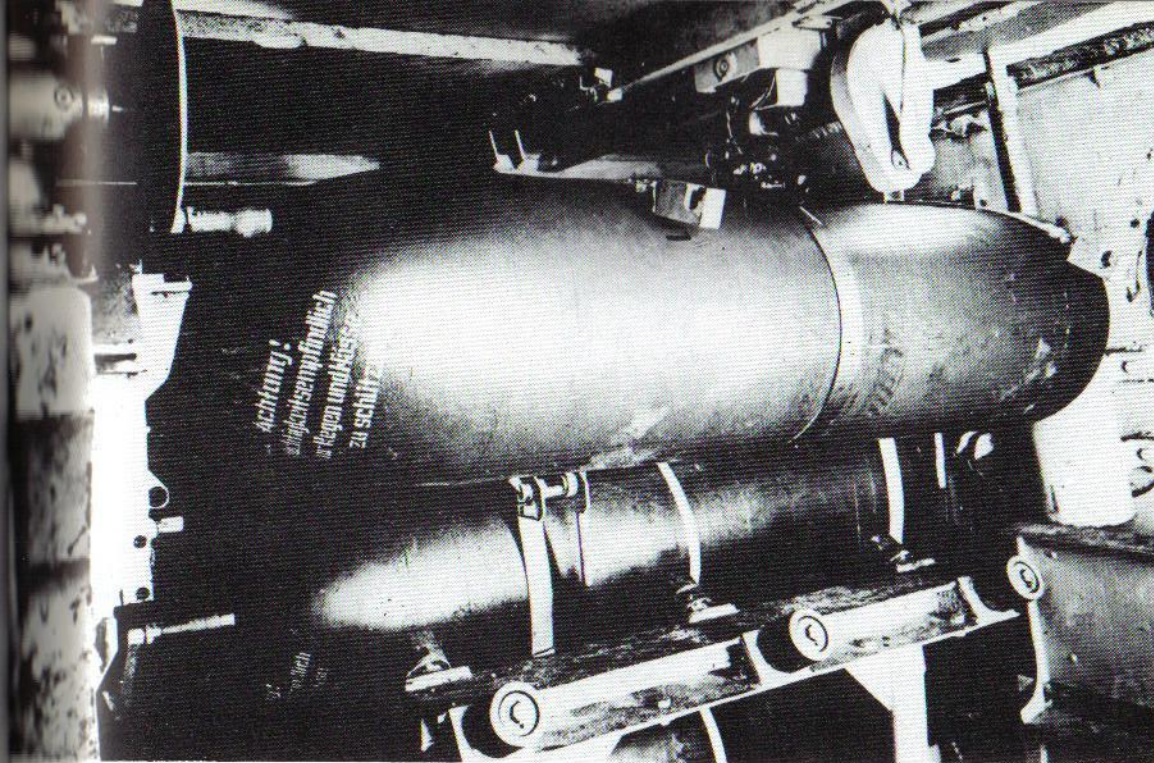

Above: Loading the launcher by means of a loading rod attached to the bottom of the rocket. The short longitudinal grooves on the back wall of the projectile help it to engage the grooves of the rifling better.

Upper left: With the help of the trolley attached to the turret roof, the rockets are moved individually to their racks.

Left: Setting the igniter into a slide on the opened breechblock. Before this, the igniter cartridge was screwed into the rear socket of the loaded rocket.

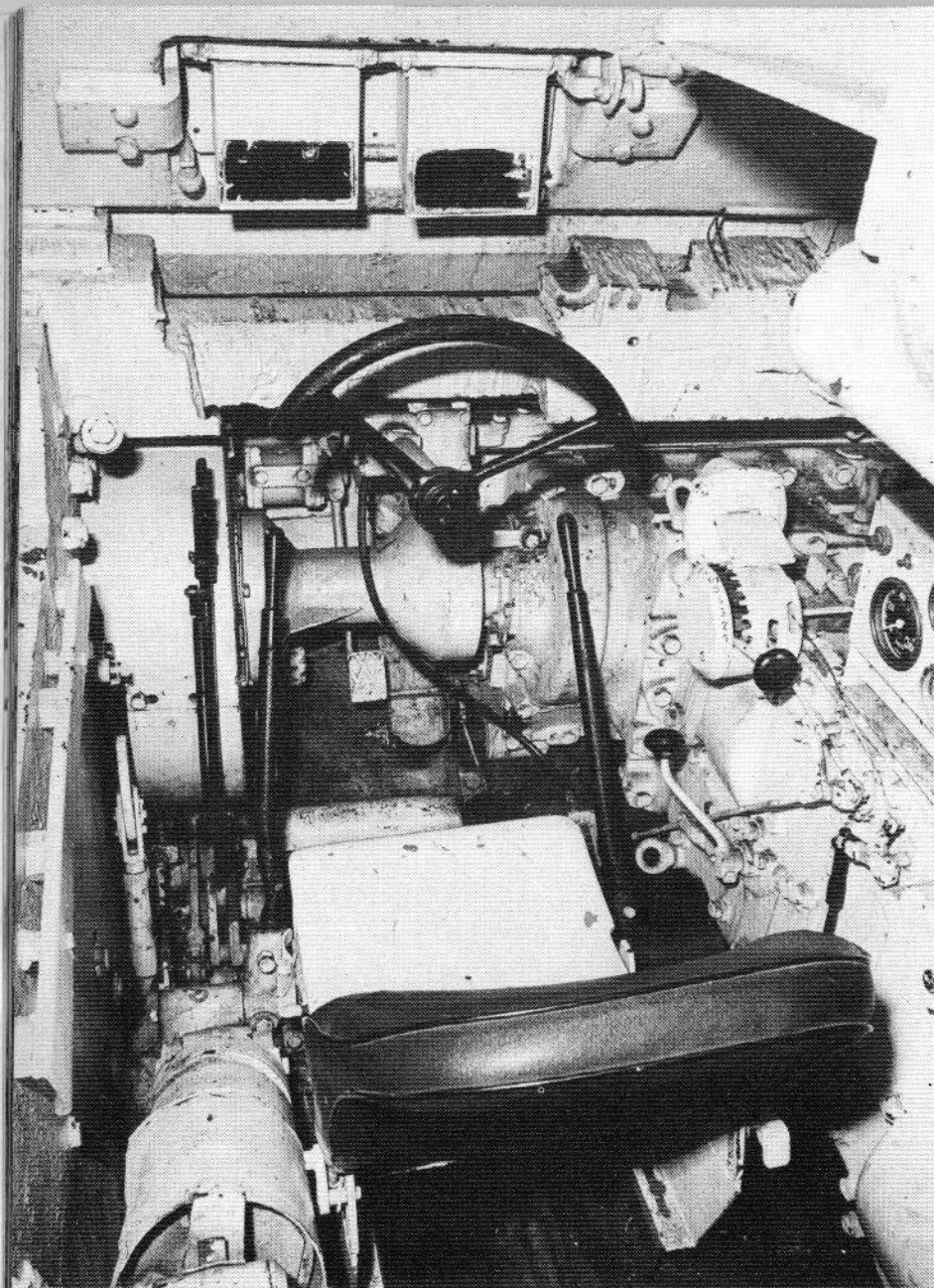

The driver's seat located in the left front of the launcher, with the quarter-circular steering wheel and, over it, the visors of the two periscopes. At right is the shift housing of the eight-speed gearbox, and under it the direction lever.

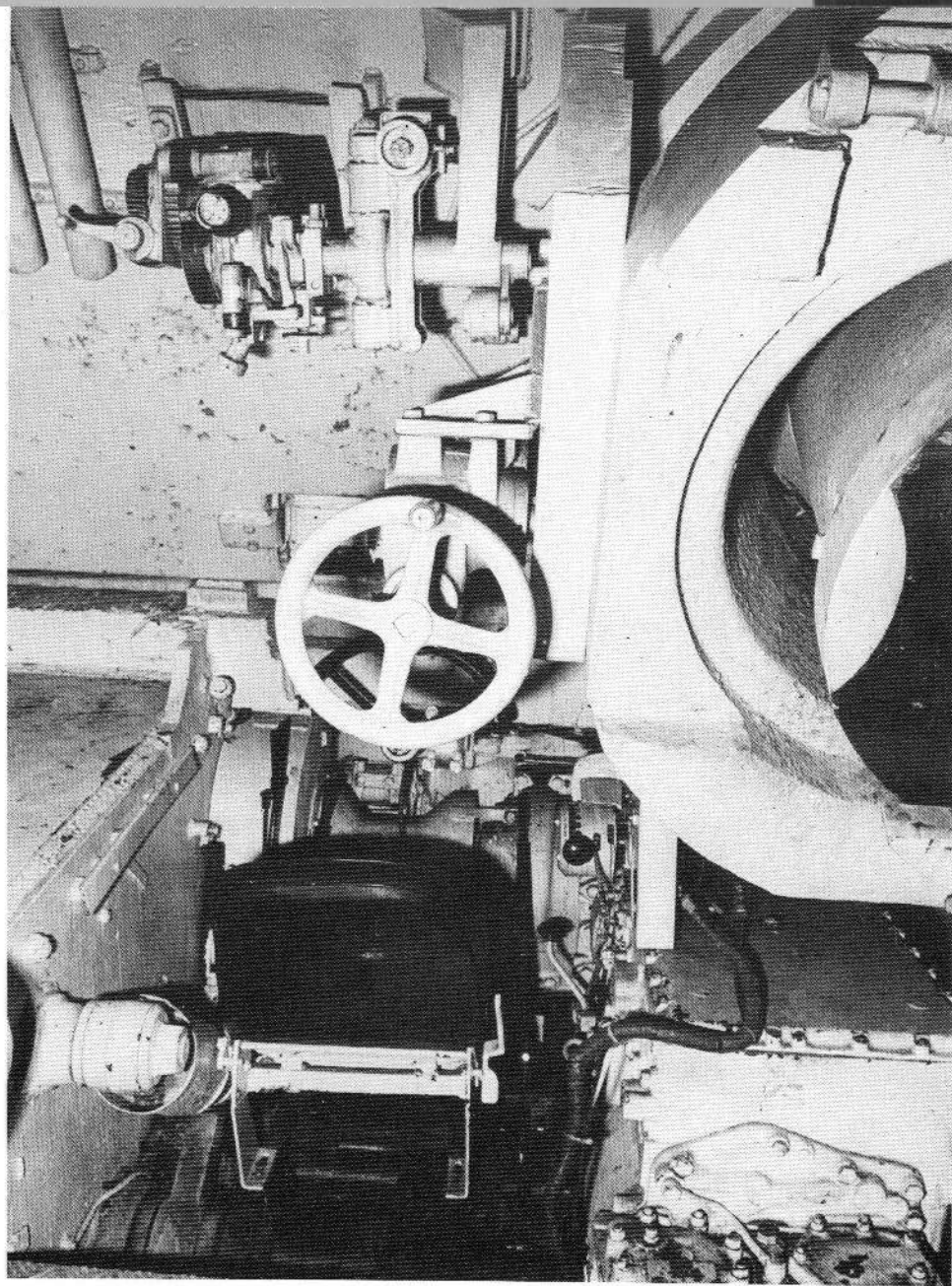

A look at the launcher's elevation aiming gear. Over it is the adjusting rod of the aiming telescope. The rear of the driver's seat can be seen below.

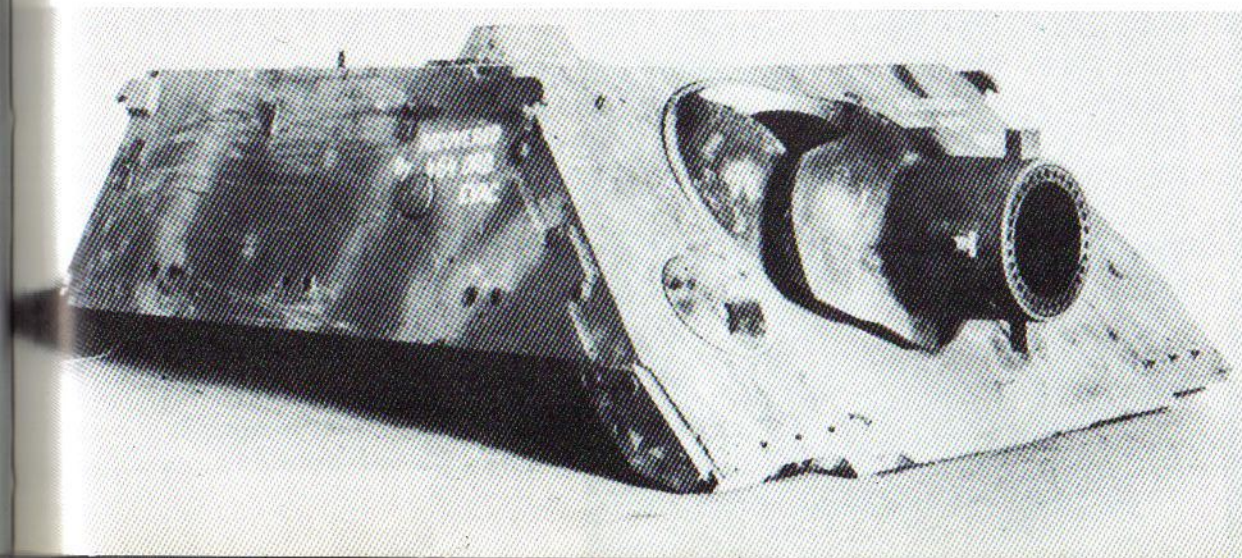
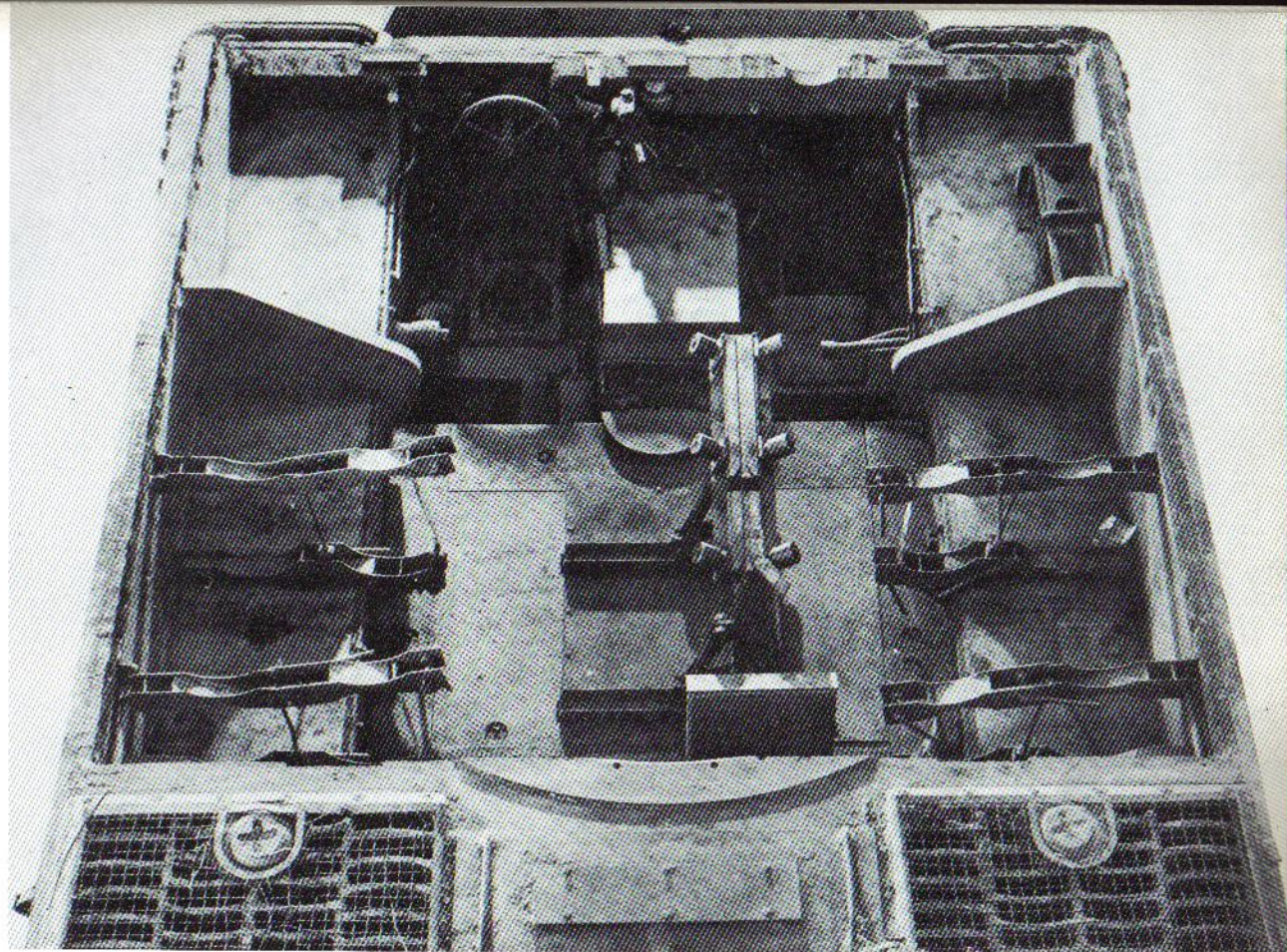
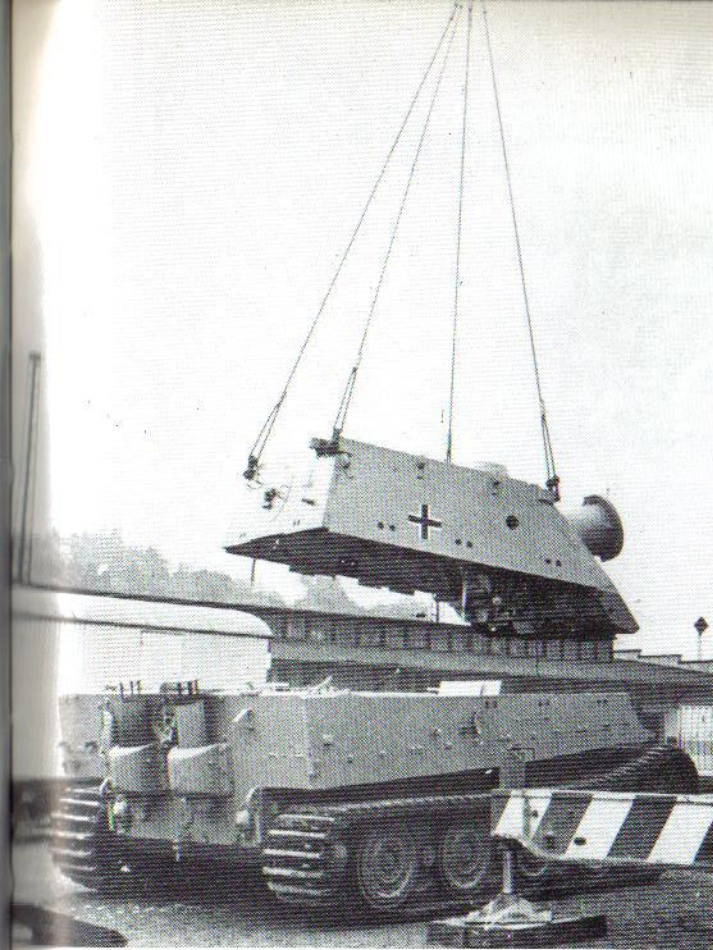

Above: A look into the hull of a Sturmtiger from which the superstructure has been removed. In the foreground the engine compartment cover can be seen, with the radiator grilles on both sides including integrated fuel filler caps. On the two track covers in the fighting compartment are the ammunition racks. At the right front is the baseplate of the radio equipment, which has been removed.

Upper left: For maintenance work or to allow two-piece transport when the whole vehicle exceeded the load limit, the complete superstructure could be lifted off after the holding bolts were removed.

Left: A superstructure removed at an American installation and put down on a concrete slab.

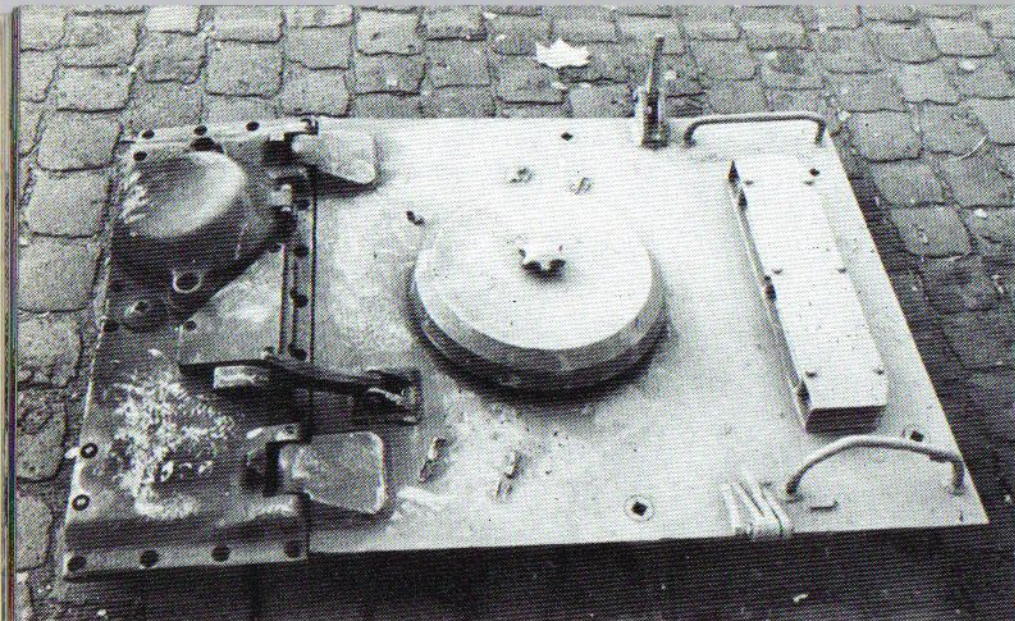

Above: Lifted-off engine compartment cover. At right is the covering for the exhaust system. Behind the round plate in the center is the engine room ventilator. The round cover at left covers the opening on which the air supply shaft was placed for underwater operation (only present in some of the earlier Tigers).

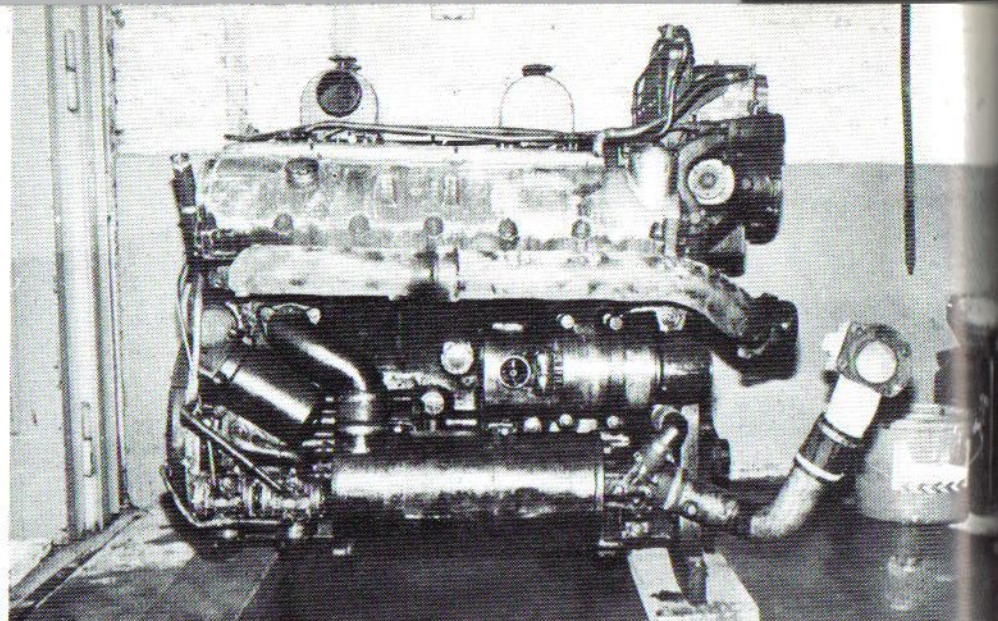

Above: Side view of the removed Maybach V-12 HL 210 P 45 motor. Mounted at lower left are the two fuel pumps, with the engine oil filter diagonally above them. Next to it is the oil cooler, with the generator over it. Next to the valve cover at the top is the right exhaust pipe.

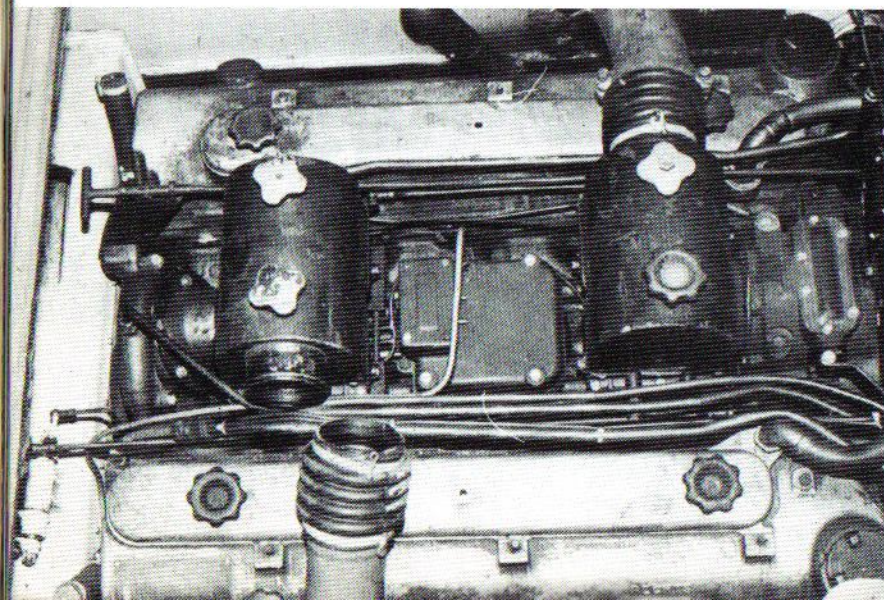

Far left: Top view of the installed motor with the two air filters.

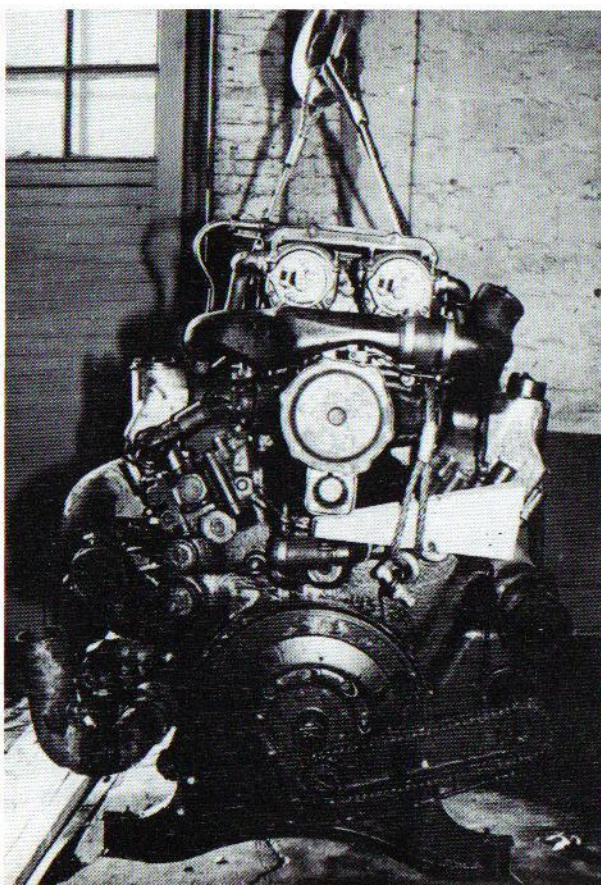

Left: Rear view of the removed motor.



## COMBAT HISTORY

Only a few details are known of this machine, which was feared by the Allies. The Sturmtiger was used by three companies, 1000, 1001 and 1002. In November of 1944 Companies 1000 and 1001 were each equipped with four mortars for use in the Ardennes offensive.

Company 1000 was transferred to the area west of Trier in December. After three technical failures, the company went into combat with one Sturmtiger on the Alsatian border.

Company 1001 (Hauptmann von Gottberg) saw action in the Gemünd area (in the

western Eifel) in November and December, and near Düren and Euskirchen in January of 1945. There the destructive effect of the mortar was proved in an attack on a village occupied by Sherman M4 tanks.

Three Sturmtigers were ferried across the Rhine at Bonn in March of 1945. Their last action took place east of Bonn. Because of a shortage of ammunition, the vehicles were destroyed by their crews.

Company 1002 (Oberleutnant Zippel), formed somewhat later, first saw action (with six mortars) in the Reichswald area. In March of 1945 it was moved back across the Rhine at Rheinberg. It saw action on R 223 near

This Sturmtiger of Sturmtiger Company 1001 was found at Drolshagen near Bonn by the 8th (US) Infantry Division on April 11, 1945. A noteworthy detail of this vehicle is the steel armor plate added to the front of the hull.

Dorsten and Kirchhellen, then retreated eastward via Polsum, Marl and Datteln. East of Datteln the Sturmtiger mortars were blown up for lack of ammunition, and the company was taken prisoner near Minden in the Sauerland.

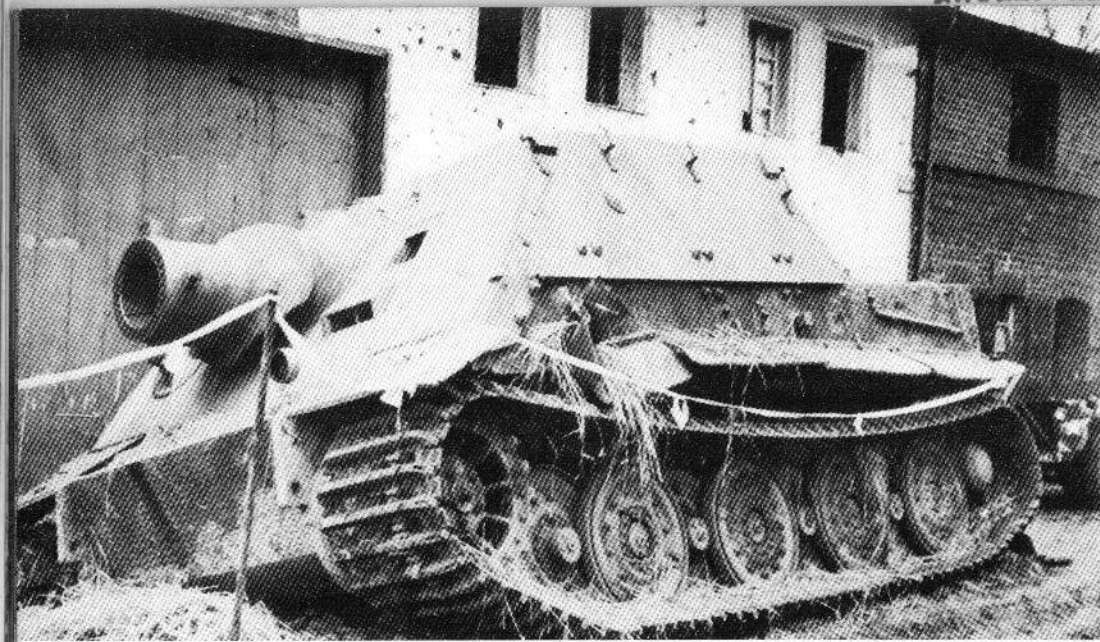

Above: This Sturmtiger was left behind in a village near the Reichswald after a track was damaged. There it fell into the hands of soldiers of the 30th (US) Infantry Division on February 28, 1945.

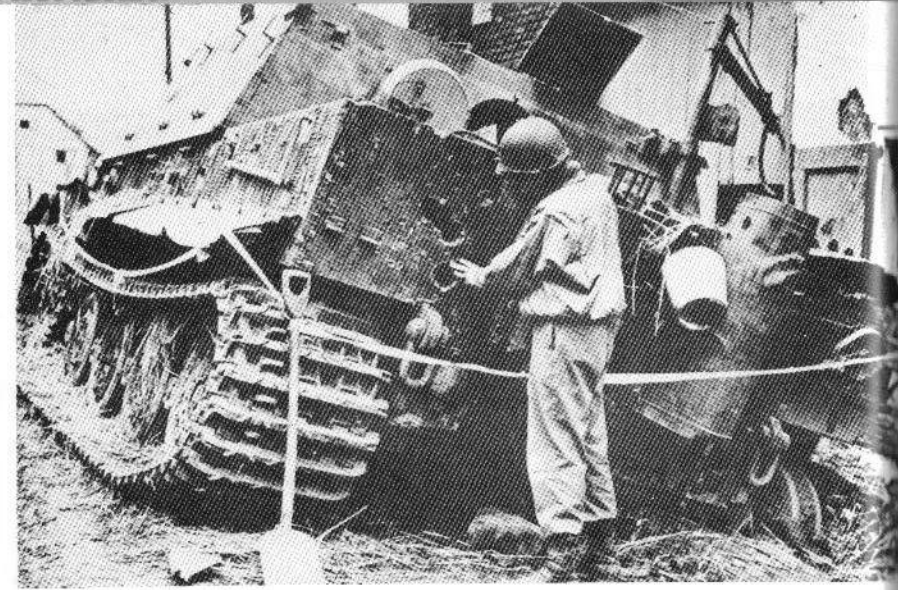

Above: Rear view of this launcher, which was shot at several times (perhaps after being abandoned). A GI examines one of the bullet holes in this vehicle, which has meanwhile been roped off.

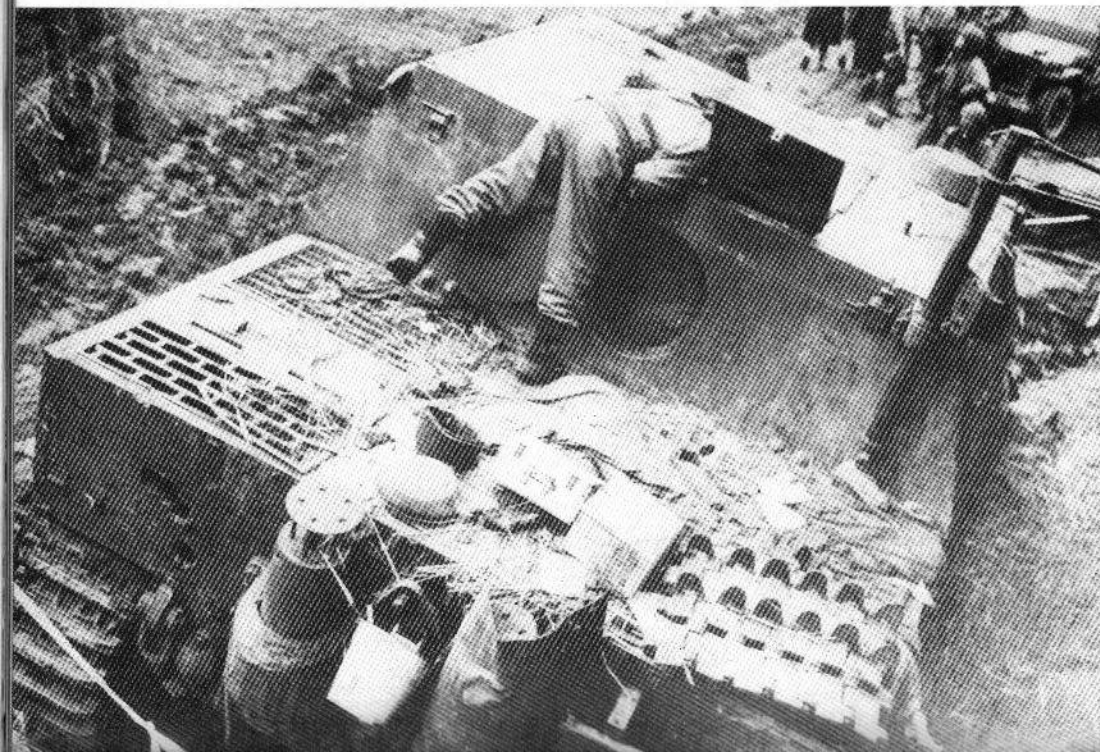

Lower left: Upper rear view of the captured Sturmtiger. On the rear is a section of track, with which the crew tried to repair the damaged track.

Below: The Sherman ARV Recovery Tank passing by the Sturmtiger would scarcely have been able to move this heavy weight.







Technical evaluation teams formed for such purposes were particularly interested in secret weapons, as the feared Sturmtiger was regarded by the Allies at that time. The photo shows the barrel position in which the launcher was found.



Upper right: This souvenir photo of a GI beside the now-lowered launcher barrel makes clear that the launcher was still loaded. Screwed into the front of the rocket is the igniter.

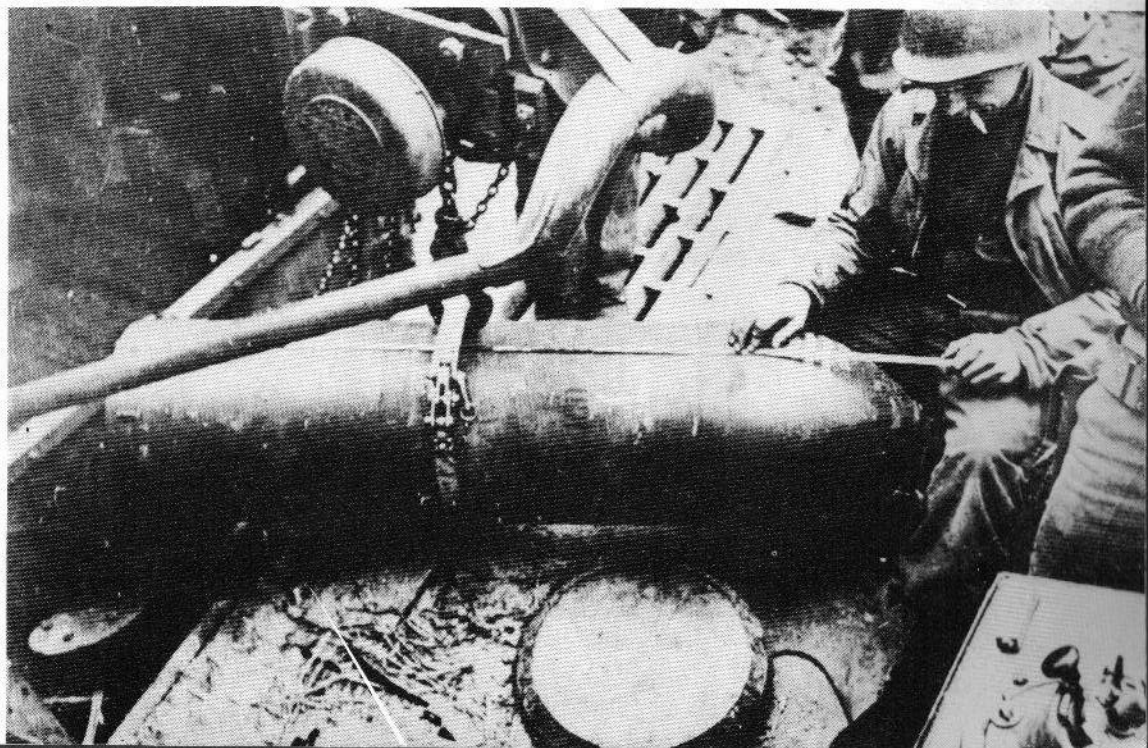

Right: After the laborious job of unloading, a 38cm rocket hanging from a crane truck was measured.



All three of the armored vehicles treated in this volume can be seen at Aberdeen (USA), a Jagdtiger in Bovington (GB) and a Sturmpanzer IV in Koblenz.

The pictures at left are photographs of vehicles (unfortunately painted in non-authentic camouflage patterns) at Aberdeen. The upper picture shows a captured Sturmpanzer IV on its arrival at Aberdeen. The documentation includes the unit (464th Ordnance Engineer Section) and the names of the three sergeants who recovered the vehicle,

Right: 1944 Jagdtiger.  
In addition to the  
paint scheme shown  
here, there was also a  
khaki version with  
irregular olive spots.

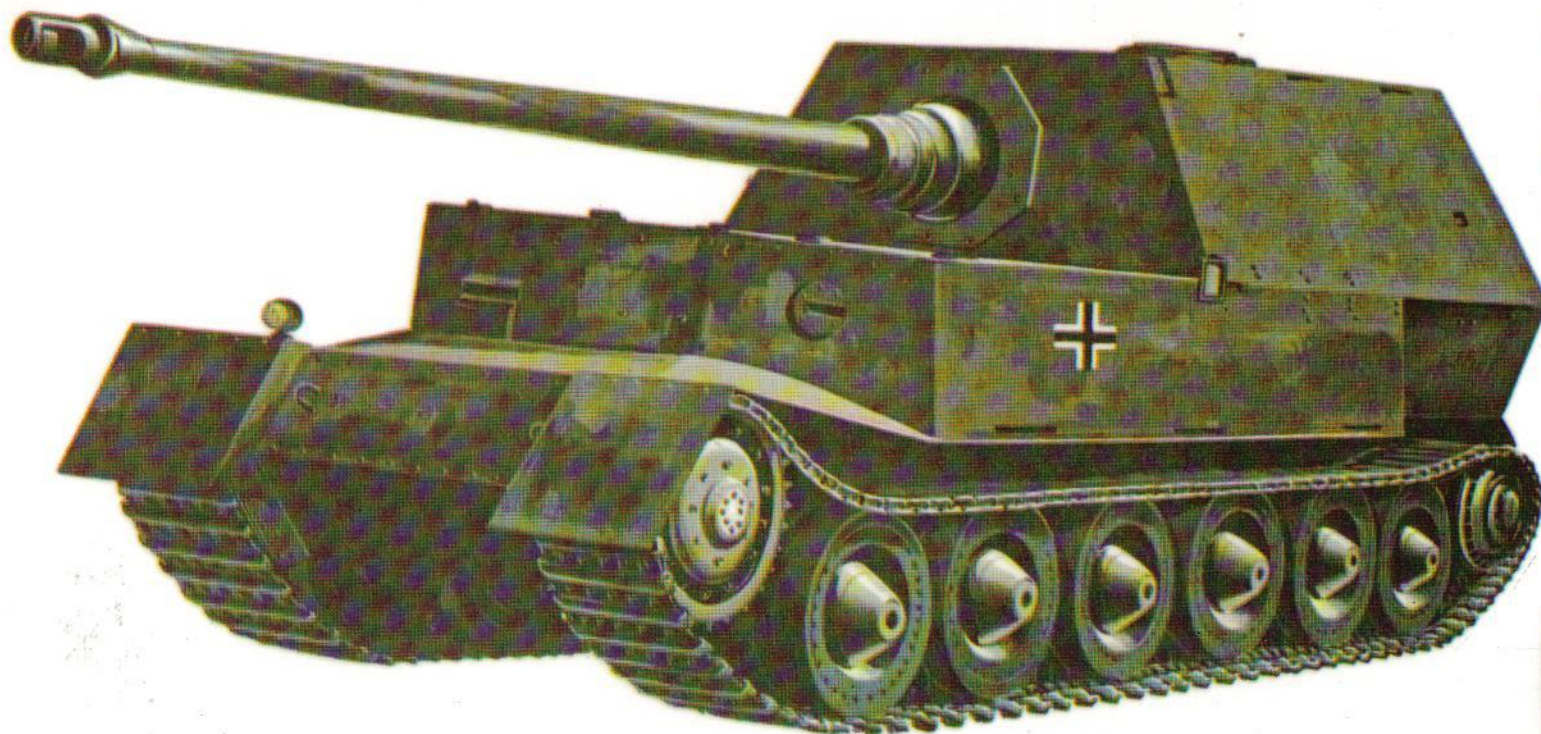
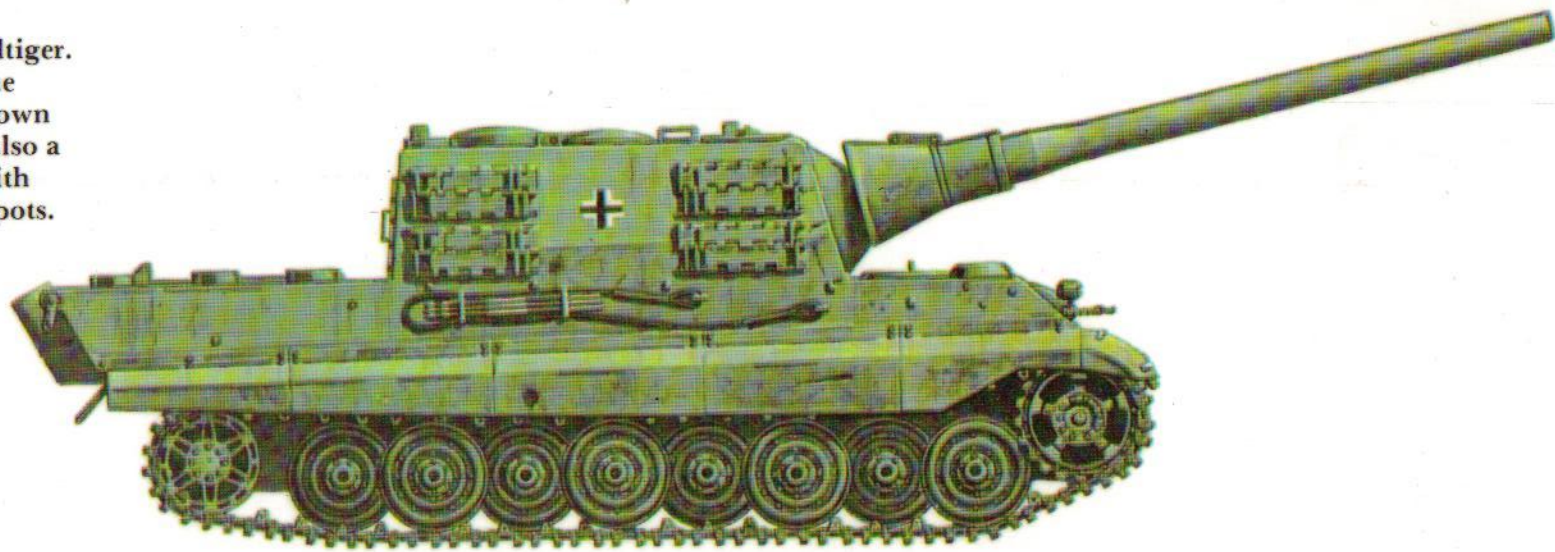

Left: The armor of the  
“Elefant” was 200mm  
thick at the front, but  
only 90 to 80mm thick  
on the sides and the  
rear surface.



ISBN 0-88740-239-9